

## CHAPTER 3A. GENERAL

### Section 3A.01 Functions and Limitations

#### Support:

01 Markings on highways and on private roads open to public travel have important functions in providing guidance and information for the road user. Major marking types include pavement and curb markings, delineators, colored pavements, channelizing devices, and islands. In some cases, markings are used to supplement other traffic control devices such as signs, signals, and other markings. In other instances, markings are used alone to effectively convey regulations, guidance, or warnings in ways not obtainable by the use of other devices.

02 Markings have limitations. Visibility of the markings can be limited by snow, debris, and water on or adjacent to the markings. Marking durability is affected by material characteristics, traffic volumes, weather, and location. However, under most highway conditions, markings provide important information while allowing minimal diversion of attention from the roadway.

### Section 3A.02 Standardization of Application

#### Standard:

01 **Each standard marking shall be used only to convey the meaning prescribed for that marking in this Manual. When used for applications not described in this Manual, markings shall conform in all respects to the principles and standards set forth in this Manual.**

#### Guidance:

02 *Before any new highway, private road open to public travel (see definition in Section 1A.13), paved detour, or temporary route is opened to public travel, all necessary markings should be in place.*

#### Standard:

03 **Markings that must be visible at night shall be retroreflective unless ambient illumination assures that the markings are adequately visible. All markings on Interstate highways shall be retroreflective.**

04 **Markings that are no longer applicable for roadway conditions or restrictions and that might cause confusion for the road user shall be removed or obliterated to be unidentifiable as a marking as soon as practical.**

#### Option:

05 Until they can be removed or obliterated, markings may be temporarily masked with tape that is approximately the same color as the pavement.

### Section 3A.03 Maintaining Minimum Pavement Marking Retroreflectivity

(This Section is reserved for future text based on FHWA rulemaking.)

### Section 3A.04 Materials

#### Support:

01 Pavement and curb markings are commonly placed by using paints or thermoplastics; however, other suitable marking materials, including raised pavement markers and colored pavements, are also used. Delineators and channelizing devices are visibly placed in a vertical position similar to signs above the roadway.

01A (DE Revision) [DelDOT's Striping Item Usage Guidelines provides guidance regarding pavement marking materials for various applications along state-maintained roadways.](#)

02 Some marking systems consist of clumps or droplets of material with visible open spaces of bare pavement between the material droplets. These marking systems can function in a manner that is similar to the marking systems that completely cover the pavement surface and are suitable for use as pavement markings if they meet the other pavement marking requirements of the highway agency.

#### Guidance:

03 *The materials used for markings should provide the specified color throughout their useful life.*

04 *Consideration should be given to selecting pavement marking materials that will minimize tripping or loss of traction for road users, including pedestrians, bicyclists, and motorcyclists.*

05 *Delineators should not present a vertical or horizontal clearance obstacle for pedestrians.*

### Section 3A.05 Colors

#### Standard:

01 **Markings shall be yellow, white, red, blue, or purple. The colors for markings shall conform to the standard highway colors. Black in conjunction with one of the colors mentioned in the first sentence of this paragraph shall be a usable color.**

02 **When used, white markings for longitudinal lines shall delineate:**

- A. **The separation of traffic flows in the same direction, or**
- B. **The right-hand edge of the roadway.**

03 **When used, yellow markings for longitudinal lines shall delineate:**

- A. **The separation of traffic traveling in opposite directions,**
- B. **The left-hand edge of the roadways of divided highways and one-way streets or ramps, or**
- C. **The separation of two-way left-turn lanes and reversible lanes from other lanes.**

04 **When used, red raised pavement markers or delineators shall delineate:**

- A. **Truck escape ramps, or**
- B. **One-way roadways, ramps, or travel lanes that shall not be entered or used in the direction from which the markers are visible.**

05 **When used, blue markings shall supplement white markings for parking spaces for persons with disabilities.**

06 **When used, purple markings shall supplement lane line or edge line markings for toll plaza approach lanes that are restricted to use only by vehicles with registered electronic toll collection accounts.**

#### Option:

07 Colors used for official route shield signs (see Section 2D.11) may be used as colors of symbol markings to simulate route shields on the pavement (see Section 3B.20.)

08 Black may be used in combination with the colors mentioned in the first sentence of Paragraph 1 where a light-colored pavement does not provide sufficient contrast with the markings.

#### *Guidance:*

08A *(DE Revision) Black contrast markings should be used with white edge lines, broken lines, and dotted lines along all concrete roadways (see Figures 3A-1A and 3A-1B).*

08B *(DE Revision) Except as provided in Paragraph 8D, the black contrast marking patterns shown in Figure 3A-1A should be used along all interstates, freeways, and expressways with concrete pavement.*

08C *(DE Revision) The black contrast marking patterns shown in Figure 3A-1B should be used along all conventional roadways with concrete pavement.*

#### Option:

08D *(DE Revision) The black contrast marking patterns shown in Figure 3A-1B may be used along interstates, freeways, and expressways with concrete pavement based on engineering judgment.*

#### Support:

09 When used in combination with other colors, black is not considered a marking color, but only a contrast-enhancing system for the markings.

### Section 3A.06 Functions, Widths, and Patterns of Longitudinal Pavement Markings

#### Standard:

01 **The general functions of longitudinal lines shall be:**

- A. **A double line indicates maximum or special restrictions,**
- B. **A solid line discourages or prohibits crossing (depending on the specific application),**
- C. **A broken line indicates a permissive condition, and**
- D. **A dotted line provides guidance or warning of a downstream change in lane function.**

02 **The widths and patterns of longitudinal lines shall be as follows:**

- A. **Normal line**—4 to 6 inches wide.
- B. **Wide line**—at least twice the width of a normal line.
- C. **Double line**—two parallel lines separated by a discernible space.
- D. **Broken line**—normal line segments separated by gaps.
- E. **Dotted line**—noticeably shorter line segments separated by shorter gaps than used for a broken line. The width of a dotted line extension shall be at least the same as the width of the line it extends.

*Guidance:*

02A *(DE Revision) Double lines should consist of two parallel lines separated by a width of 6 inches.*

02B *(DE Revision) A normal line along all state-maintained roadways should be 5 inches wide.*

02C *(DE Revision) A wide line along all state-maintained roadways should be 10 inches wide.*

Support:

03 The width of the line indicates the degree of emphasis.

03A *(DE Revision) See Section 6F.78 for provisions regarding the application of temporary pavement markings.*

*Guidance:*

04 *Broken lines should consist of 10-foot line segments and 30-foot gaps, or dimensions in a similar ratio of line segments to gaps as appropriate for traffic speeds and need for delineation.*

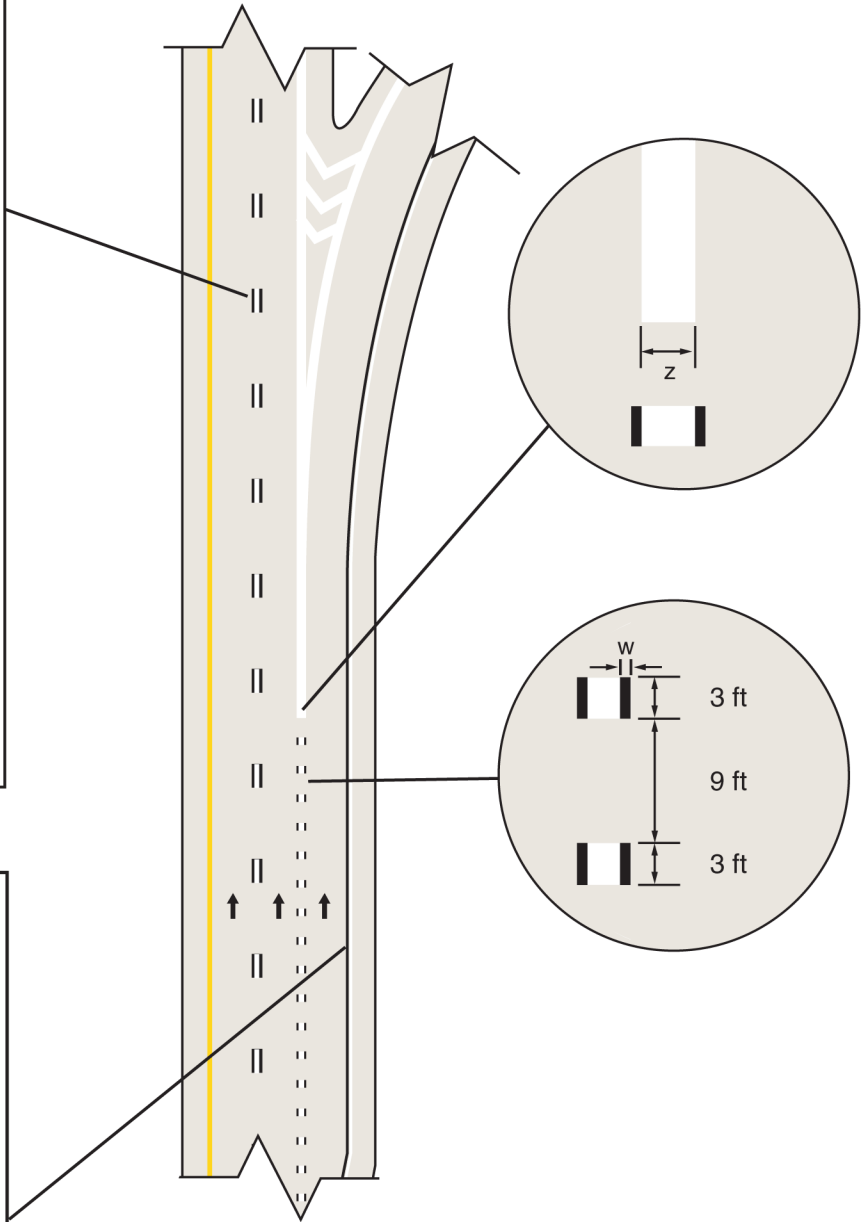
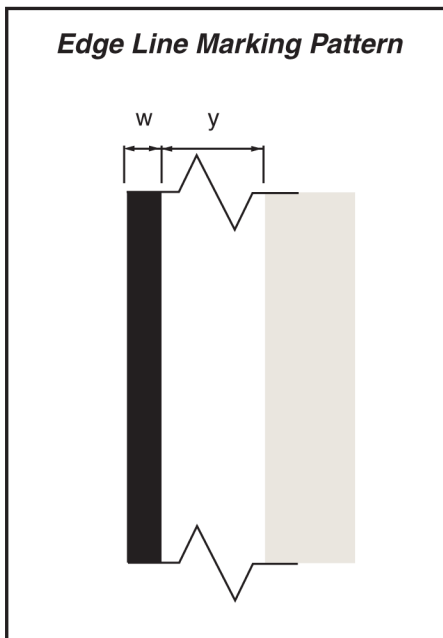
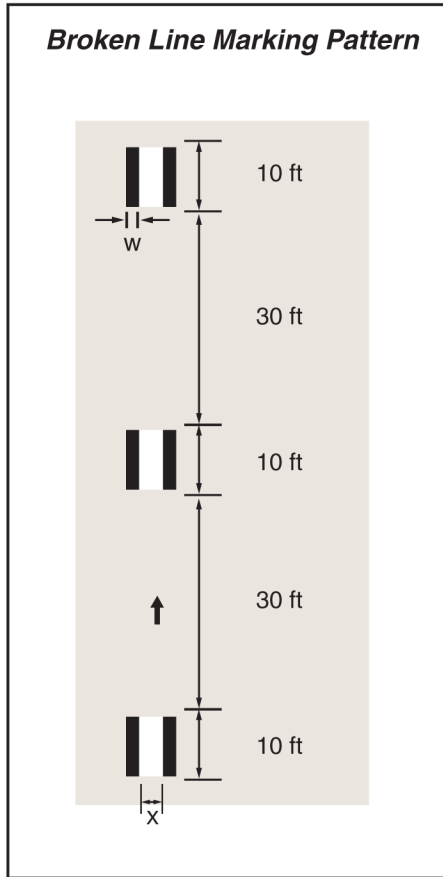
Support:

05 Patterns for dotted lines depend on the application (see Sections 3B.04 and 3B.08.)

*Guidance:*

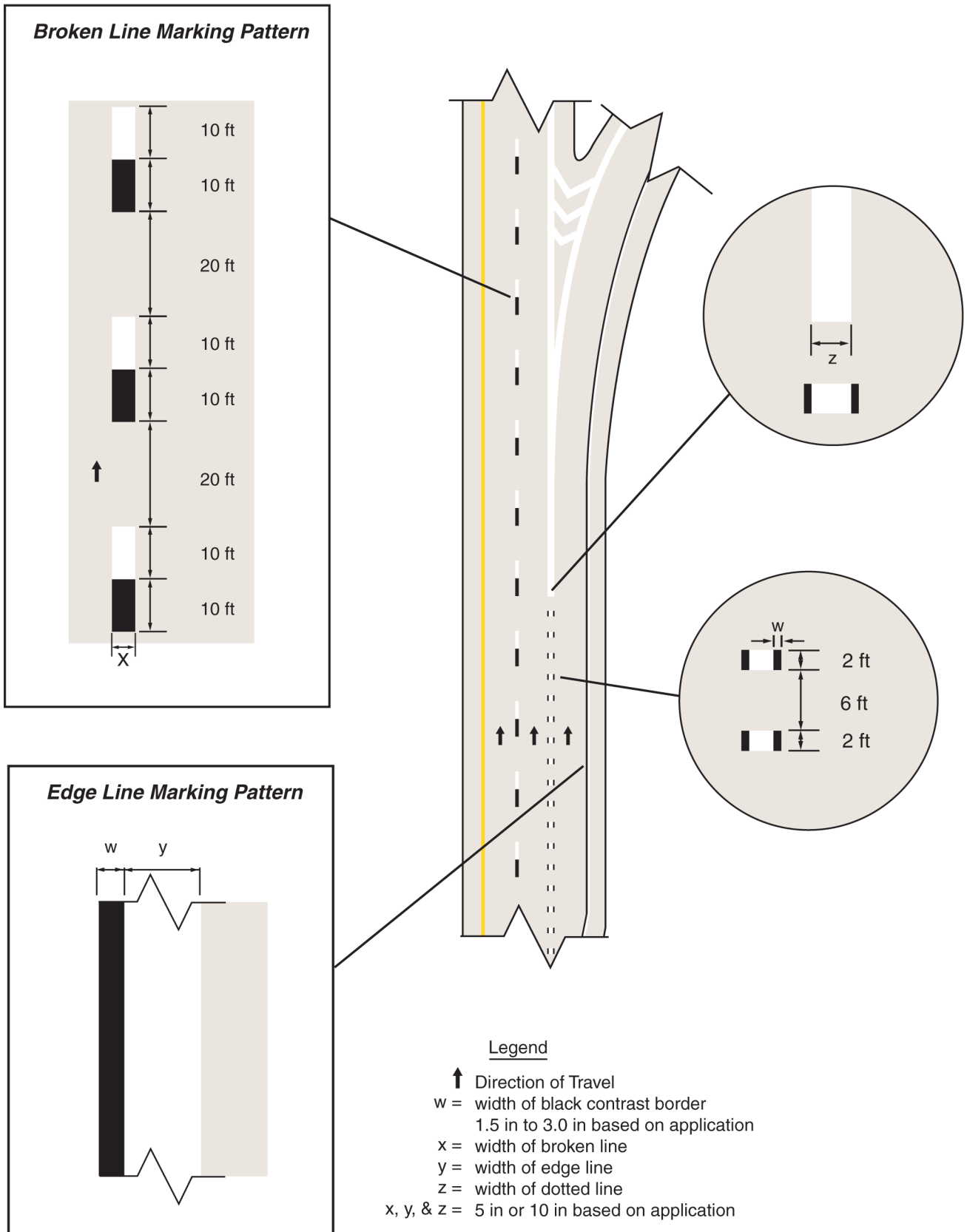
06 *(DE Revision) A dotted line for line extensions along interstates, freeways, and expressways should consist of 3-foot line segments and 9-foot gaps. A dotted line for line extensions along all other roadways should consist of 2-foot line segments and 6-foot gaps, except at roundabouts. Line extensions used at roundabouts should consist of 2-foot line segments and 2-foot gaps.*

**Figure 3A-1A. Black Contrast Marking Patterns on Interstates, Freeways or Expressways  
(Delaware Revision)**



- Legend**
- ↑ Direction of Travel
  - w = width of black contrast border  
1.5 in to 3.0 in based on application
  - x = width of broken line
  - y = width of edge line
  - z = width of dotted line
  - x, y, & z = 5 in or 10 in based on application

**Figure 3A-1B. Black Contrast Marking Patterns on All Other Roads  
(Non-Interstates, Freeways or Expressways)  
(Delaware Revision)**



(This Page Left Intentionally Blank)

## CHAPTER 3B. PAVEMENT AND CURB MARKINGS

### Section 3B.01 Yellow Center Line Pavement Markings and Warrants

#### Standard:

01 **Center line pavement markings, when used, shall be the pavement markings used to delineate the separation of traffic lanes that have opposite directions of travel on a roadway and shall be yellow.**

#### Option:

02 Center line pavement markings may be placed at a location that is not the geometric center of the roadway.

03 **(DE Revision)** On roadways without continuous center line pavement markings, short sections may be marked with center line pavement markings to control the position of traffic at specific locations, such as around curves, over hills, on approaches to grade crossings, at grade crossings, at bridges, and on approaches to intersections.

#### Standard:

04 **The center line markings on two-lane, two-way roadways shall be one of the following as shown in Figure 3B-1:**

- A. **Two-direction passing zone markings consisting of a normal broken yellow line where crossing the center line markings for passing with care is permitted for traffic traveling in either direction;**
- B. **One-direction no-passing zone markings consisting of a double yellow line, one of which is a normal broken yellow line and the other is a normal solid yellow line, where crossing the center line markings for passing with care is permitted for the traffic traveling adjacent to the broken line, but is prohibited for traffic traveling adjacent to the solid line; or**
- C. **Two-direction no-passing zone markings consisting of two normal solid yellow lines where crossing the center line markings for passing is prohibited for traffic traveling in either direction.**

05 **A single solid yellow line shall not be used as a center line marking on a two-way roadway.**

06 **The center line markings on undivided two-way roadways with four or more lanes for moving motor vehicle traffic always available shall be the two-direction no-passing zone markings consisting of a solid double yellow line as shown in Figure 3B-2.**

#### Guidance:

07 *On two-way roadways with three through lanes for moving motor vehicle traffic, two lanes should be designated for traffic in one direction by using one- or two-direction no-passing zone markings as shown in Figure 3B-3.*

#### Support:

08 Sections 11-301(c) and 11-311(c) of the “Uniform Vehicle Code (UVC)” contain information regarding left turns across center line no-passing zone markings and paved medians, respectively. The UVC can be obtained from the National Committee on Uniform Traffic Laws and Ordinances at the address shown on Page i.

#### Standard:

09 **(DE Revision)** Center line markings shall be placed on all paved roadways that have a traveled way of 19 feet or more in width and an ADT of 500 vehicles per day or greater. Center line markings shall also be placed on all paved two-way streets or highways that have three or more lanes for moving motor vehicle traffic.

#### Guidance:

10 **(DE Revision)** Center line markings should be placed on surface-treated roadways that have a traveled way of 19 feet or more in width and an ADT of 1,000 vehicles per day or greater.

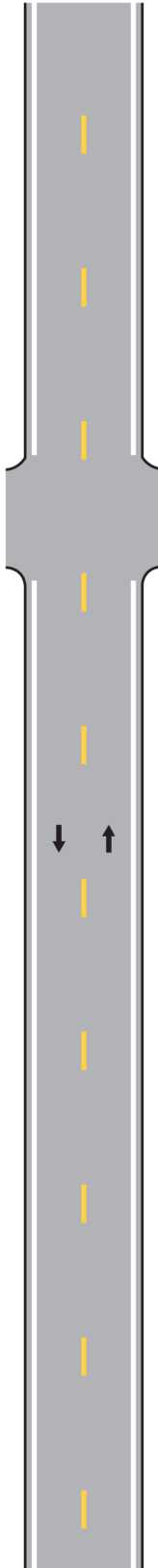
11 **(DE Revision)** Engineering judgment should be used in determining whether to place center line markings on traveled ways that are less than 19 feet wide because of the potential for traffic encroaching on the pavement edges, traffic being affected by parked vehicles, and traffic encroaching into the opposing traffic lane.

11A **(DE Revision)** Except at the intersection of state-maintained roadways and subdivision roadways, center line markings should not be placed on subdivision roadways unless engineering judgment indicates such a need.

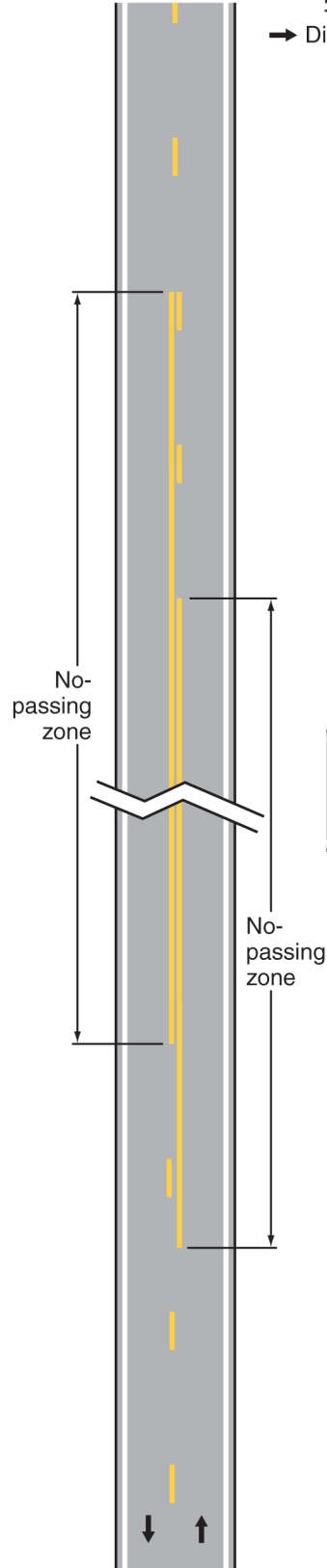
11B **(DE Revision)** Center line markings should be installed within median crossovers along divided highways where the median width is greater than or equal to 50 feet (see Figure 2B-15).

**Figure 3B-1. Examples of Two-Lane, Two-Way Marking Applications  
(Delaware Revision)**

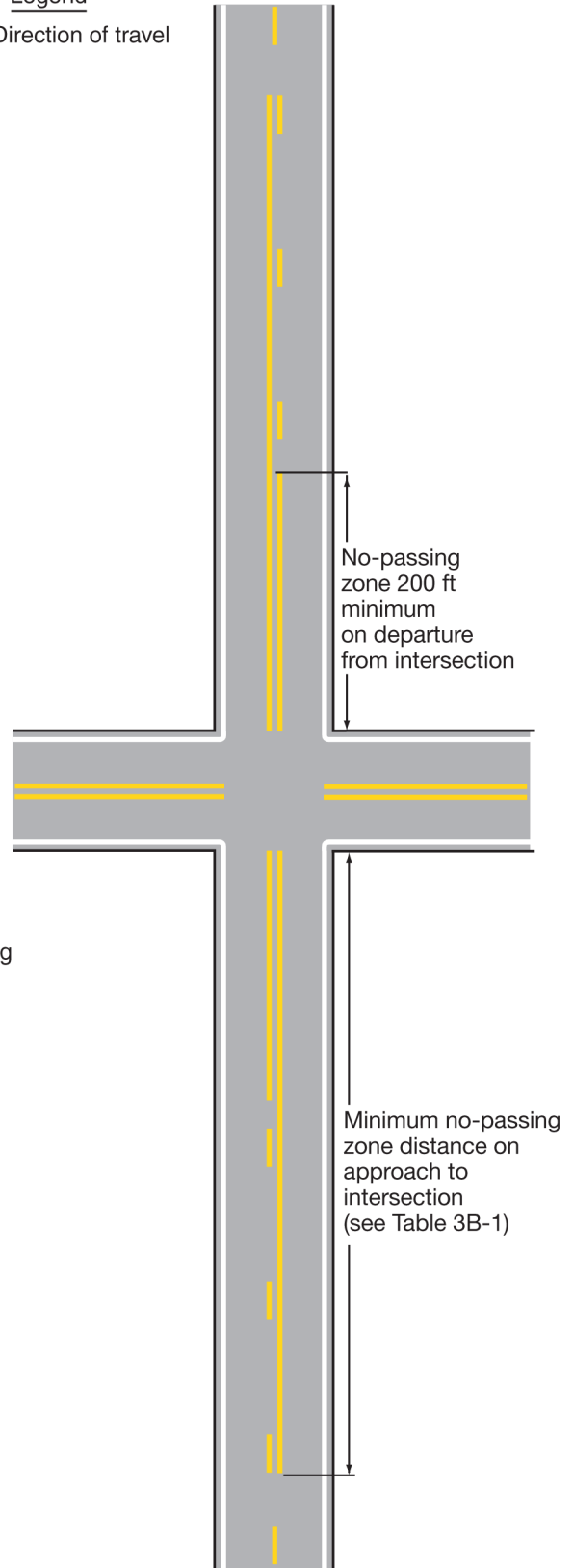
**A - Typical two-lane, two-way marking with passing permitted in both directions**



**B - Typical two-lane, two-way marking with no-passing zones**



**C - Typical two-lane, two-way marking approaching an intersection**



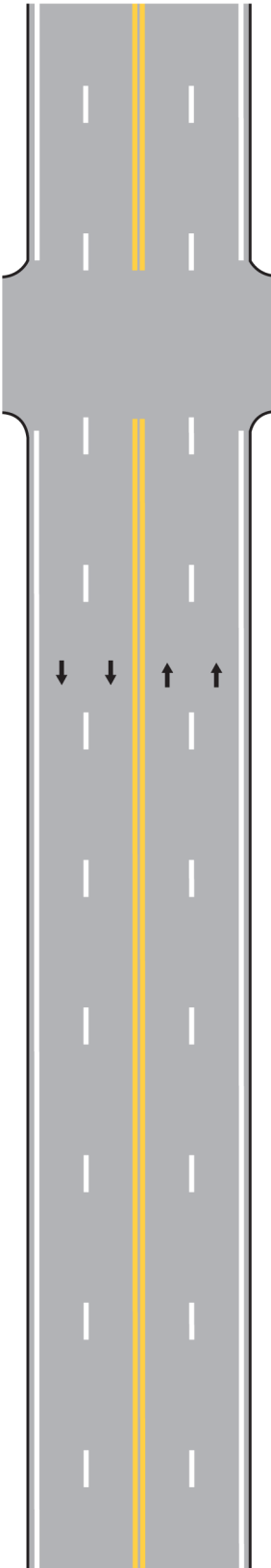


**Figure 3B-2. Examples of Four-or-More Lane, Two-Way Marking Applications  
(Delaware Revision)**

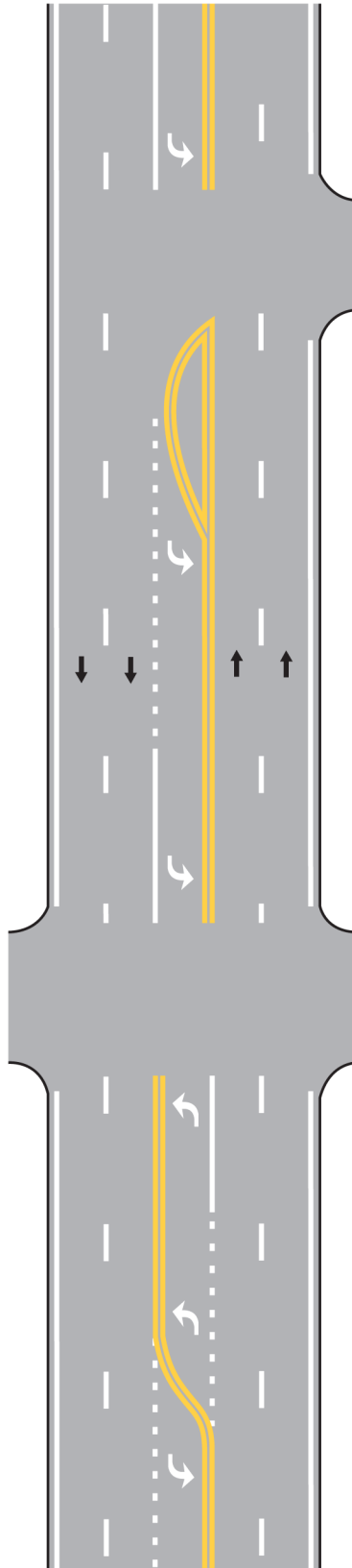
Legend

→ Direction of travel

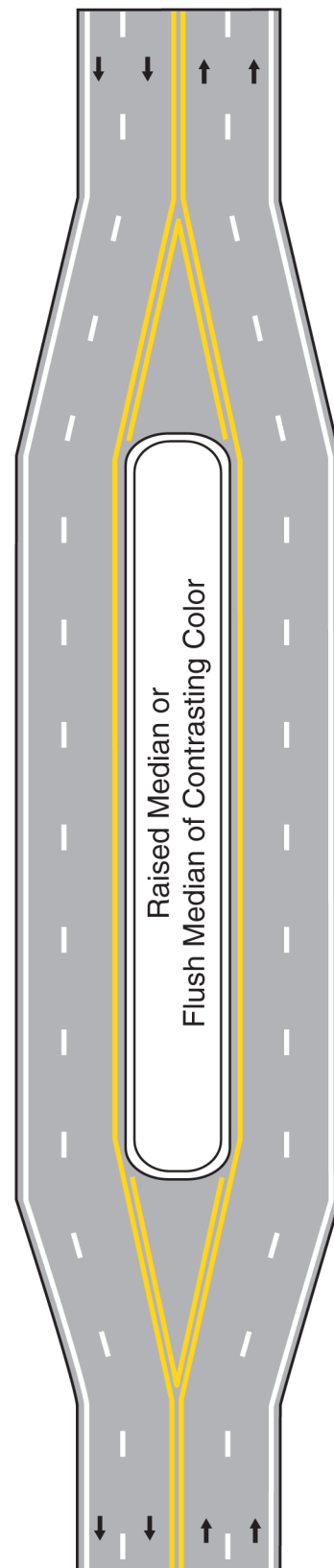
**A - Typical multi-lane, two-way marking**



**B - Typical multi-lane, two-way marking with single lane left turn channelization**



**C - Typical multi-lane, two-way marking with raised median or flush median of contrasting color**



Option:

12 (DE Revision) Center line markings may be placed on paved roadways that are 19 feet or more in width and have an ADT less than 500 vehicles per day where engineering judgment indicates such a need.

12A (DE Revision) Center line markings may be placed on surface-treated roadways that are 19 feet or more in width and have an ADT less than 1,000 vehicles per day where engineering judgment indicates such a need.

12B (DE Revision) Center line markings may be installed within median crossovers along divided highways where the median width is greater than or equal to 30 feet and less than 50 feet where engineering judgment indicates such a need (see Figure 2B-15).

13 If a traffic count is not available, the ADTs described in this Section may be estimates that are based on engineering judgment.

**Section 3B.02 No-Passing Zone Pavement Markings and Warrants**

**Standard:**

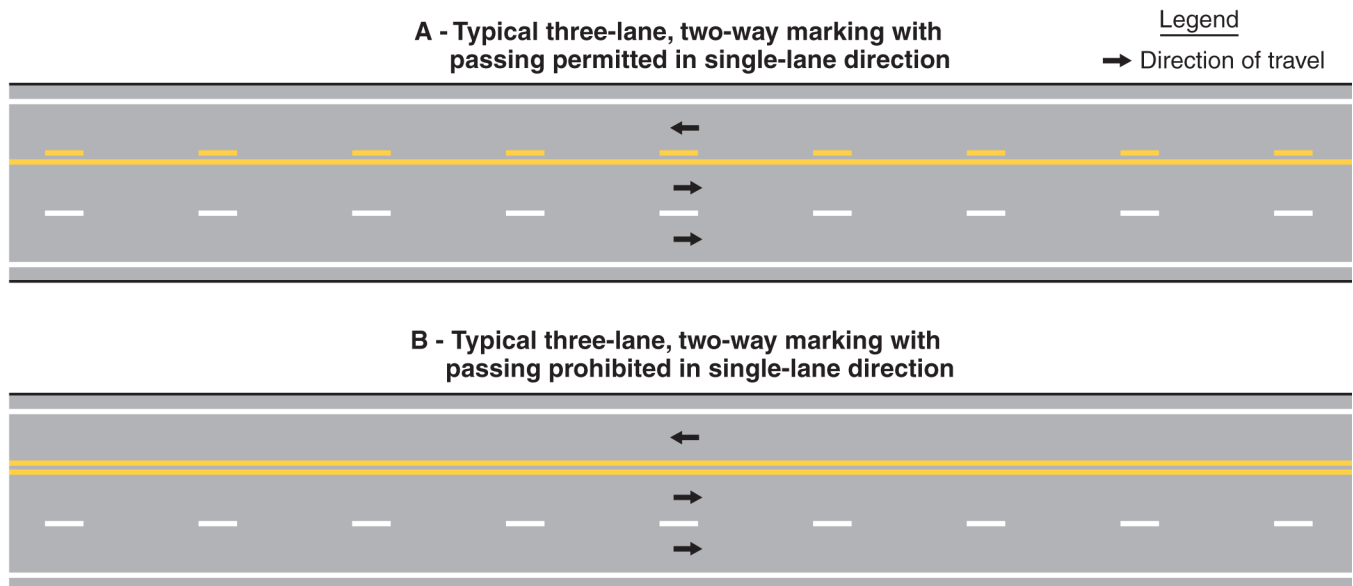
01 No-passing zones shall be marked by either the one direction no-passing zone pavement markings or the two-direction no-passing zone pavement markings described in Section 3B.01 and shown in Figures 3B-1 and 3B-3.

02 When center line markings are used, no-passing zone markings shall be used on two-way roadways at lane-reduction transitions (see Section 3B.09) and on approaches to obstructions that must be passed on the right (see Section 3B.10).

03 On two-way, two- or three-lane roadways where center line markings are installed, no-passing zones shall be established at vertical and horizontal curves and other locations where an engineering study indicates that passing must be prohibited because of inadequate sight distances or other special conditions.

04 On roadways with center line markings, no-passing zone markings shall be used at horizontal or vertical curves where the passing sight distance is less than the minimum shown in Table 3B-1 for the 85<sup>th</sup>-percentile speed or the posted or statutory speed limit. The passing sight distance on a vertical curve is the distance at which an object 3.5 feet above the pavement surface can be seen from a point 3.5 feet above the pavement (see Figure 3B-4). Similarly, the passing sight distance on a horizontal curve is the distance measured along the center line (or right-hand lane line of a three-lane roadway) between two points 3.5 feet above the pavement on a line tangent to the embankment or other obstruction that cuts off the view on the inside of the curve (see Figure 3B-4).

**Figure 3B-3. Examples of Three-Lane, Two-Way Marking Applications**



**Table 3B-1. Minimum Passing Sight Distances for No-Passing Zone Markings**

85th-Percentile or Posted or Statutory Speed Limit	Minimum Passing Sight Distance
25 mph	450 feet
30 mph	500 feet
35 mph	550 feet
40 mph	600 feet
45 mph	700 feet
50 mph	800 feet
55 mph	900 feet
60 mph	1,000 feet
65 mph	1,100 feet
70 mph	1,200 feet

*Guidance:*

04A (DE Revision) *Where center line markings are used, no-passing zone markings on all approaches to an intersection should be based on the distances shown in Table 3B-1. Where center line markings are used, no-passing zone markings should extend a minimum of 200 feet on all departure legs of an intersection (see Figure 3B-1).*

**Support:**

05 The upstream end of a no-passing zone at point “a” in Figure 3B-4 is that point where the sight distance first becomes less than that specified in Table 3B-1. The downstream end of the no-passing zone at point “b” in Figure 3B-4 is that point at which the sight distance again becomes greater than the minimum specified.

06 The values of the minimum passing sight distances that are shown in Table 3B-1 are for operational use in marking no-passing zones and are less than the values that are suggested for geometric design by the AASHTO Policy on Geometric Design of Streets and Highways (see Section 1A.11).

*Guidance:*

07 *Where the distance between successive no-passing zones is less than 400 feet, no-passing markings should connect the zones.*

**Standard:**

08 **Where center line markings are used, no-passing zone markings shall be used on approaches to grade crossings in compliance with Section 8B.27.**

**Option:**

09 In addition to pavement markings, no-passing zone signs (see Sections 2B.28, 2B.29, and 2C.45) may be used to emphasize the existence and extent of a no-passing zone.

**Support:**

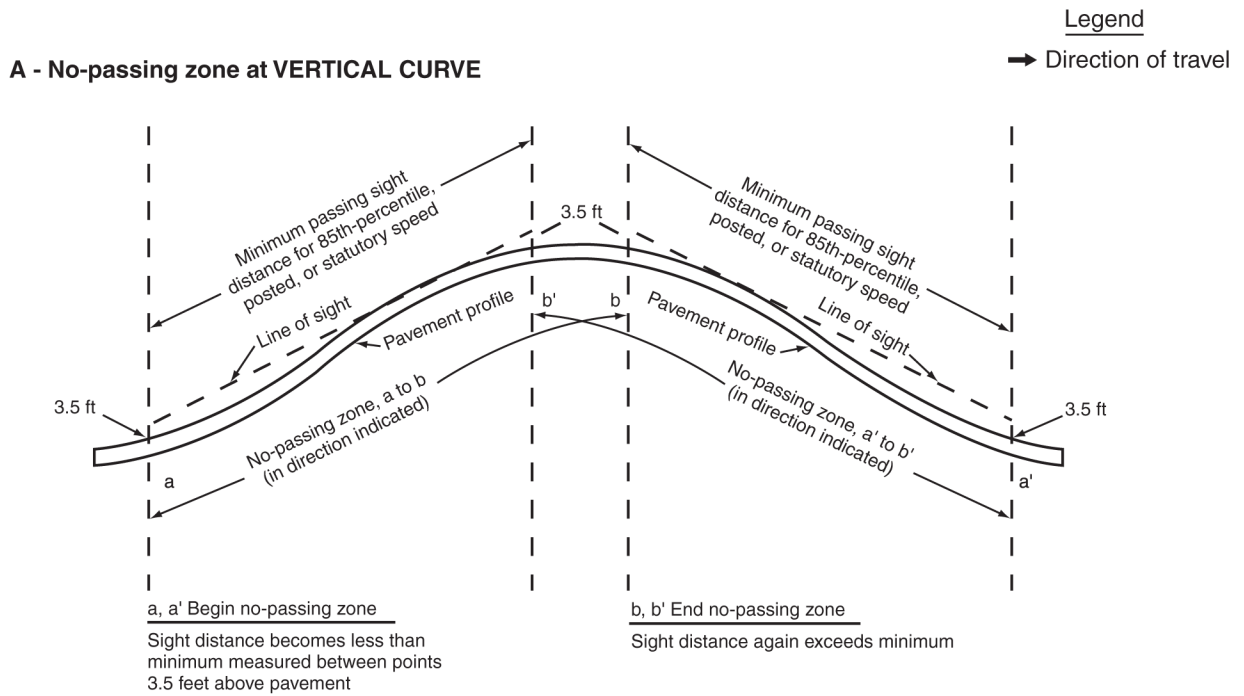
10 Section 11-307 of the “Uniform Vehicle Code (UVC)” contains further information regarding required road user behavior in no-passing zones. The UVC can be obtained from the National Committee on Uniform Traffic Laws and Ordinances at the address shown on Page i.

**Standard:**

11 **On three-lane roadways where the direction of travel in the center lane transitions from one direction to the other, a no-passing buffer zone shall be provided in the center lane as shown in Figure 3B-5. A lane-reduction transition (see Section 3B.09) shall be provided at each end of the buffer zone.**

12 **The buffer zone shall be a flush median island formed by two sets of double yellow center line markings that is at least 50 feet in length.**

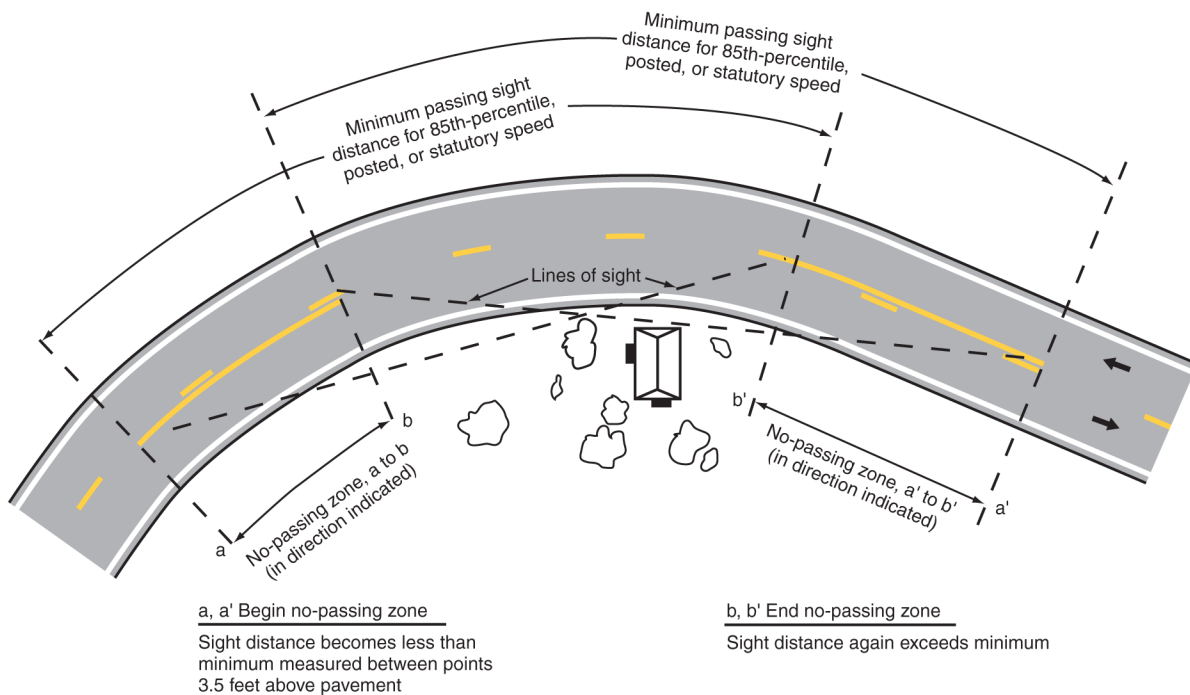
**Figure 3B-4. Method of Locating and Determining the Limits of No-Passing Zones at Curves**



**Profile View**

Note: No-passing zones in opposite directions may or may not overlap, depending on alignment

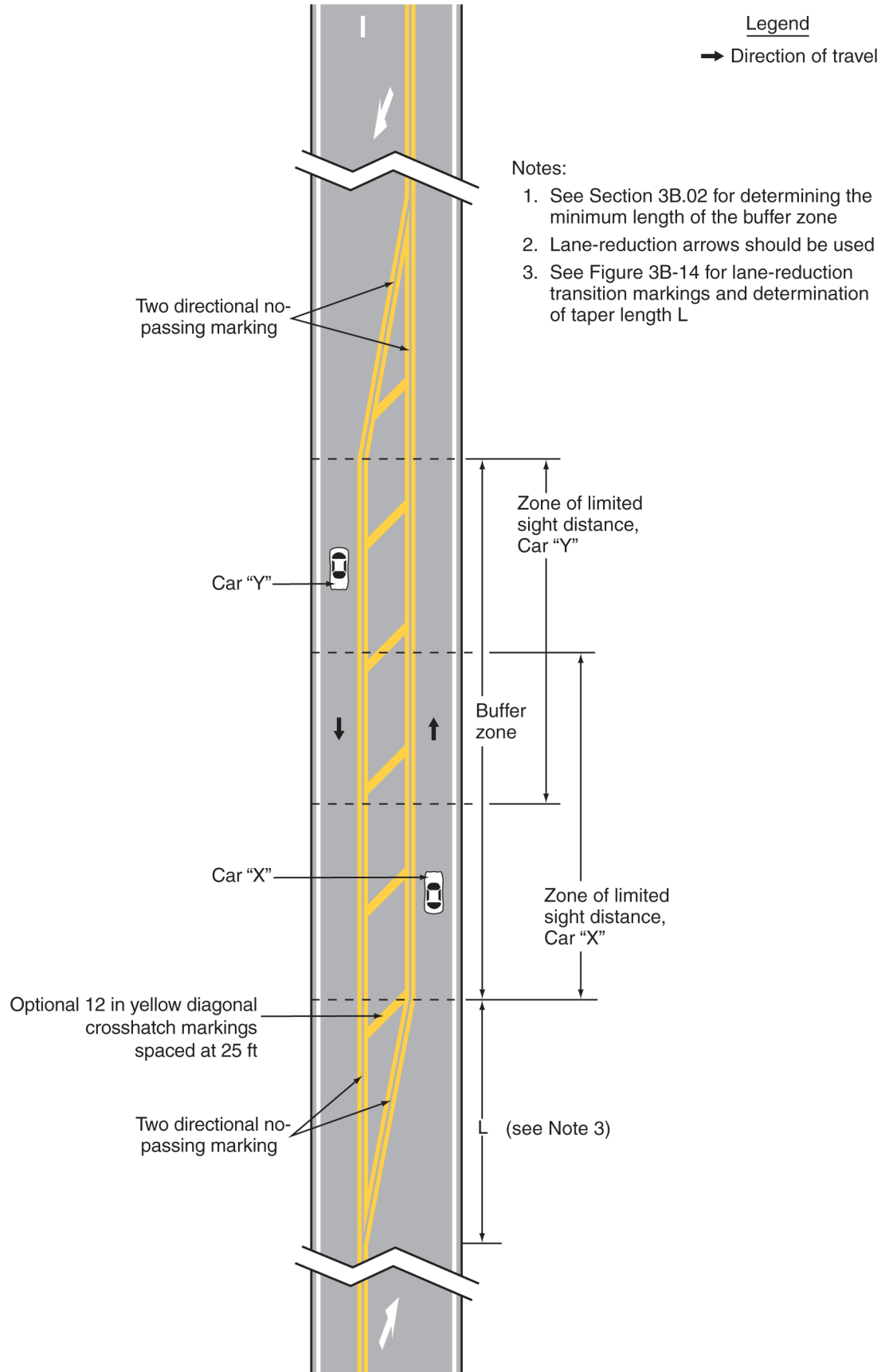
**B - No-passing zone at HORIZONTAL CURVE**



**Plan View**

Note: No-passing zones in opposite directions may or may not overlap, depending on alignment

**Figure 3B-5. Example of Application of Three-Lane, Two-Way Marking for Changing Direction of the Center Lane (Delaware Revision)**



Option:

13 Yellow diagonal crosshatch markings (see Section 3B.24) may be placed in the flush median area between the two sets of no-passing zone markings as shown in Figure 3B-5.

Guidance:

14 For three-lane roadways having a posted or statutory speed limit of 45 mph or greater, the lane transition taper length should be computed by the formula  $L = WS$ . For roadways where the posted or statutory speed limit is less than 45 mph, the formula  $L = WS^2/60$  should be used to compute the taper length.

Support:

15 Under both formulas, L equals the taper length in feet, W equals the width of the center lane or offset distance in feet, and S equals the 85<sup>th</sup>-percentile speed or the posted or statutory speed limit, whichever is higher.

Guidance:

16 The minimum lane transition taper length should be 100 feet in urban areas and 200 feet in rural areas.

**Section 3B.03 Other Yellow Longitudinal Pavement Markings**

**Standard:**

01 If reversible lanes are used, the lane line pavement markings on each side of reversible lanes shall consist of a normal broken double yellow line to delineate the edge of a lane in which the direction of travel is reversed from time to time, such that each of these markings serve as the center line markings of the roadway during some period (see Figure 3B-6).

02 Signs (see Section 2B.26), lane-use control signals (see Chapter 4M), or both shall be used to supplement reversible lane pavement markings.

03 If a two-way left-turn lane that is never operated as a reversible lane is used, the lane line pavement markings on each side of the two-way left-turn lane shall consist of a normal broken yellow line and a normal solid yellow line to delineate the edges of a lane that can be used by traffic in either direction as part of a left-turn maneuver. These markings shall be placed with the broken line toward the two-way left-turn lane and the solid line toward the adjacent traffic lane as shown in Figure 3B-7.

Guidance:

04 White two-way left-turn lane-use arrows (see Figure 3B-7), should be used in conjunction with the longitudinal two-way left-turn markings at the locations described in Section 3B.20.

05 Signs should be used in conjunction with the two-way left turn markings (see Section 2B.24).

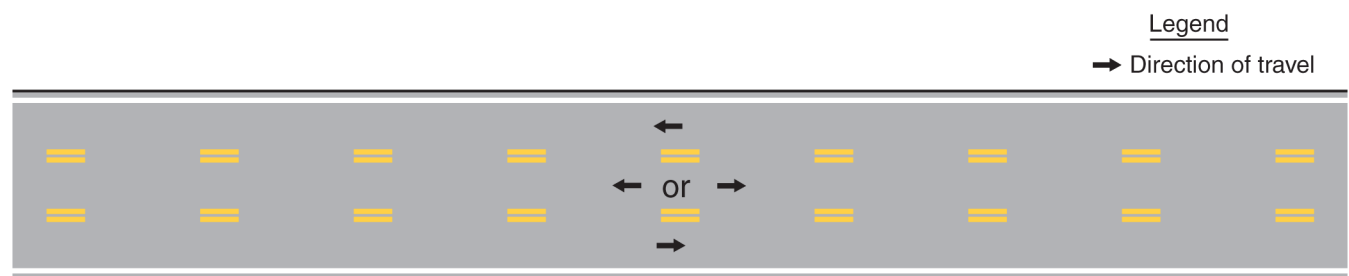
**Standard:**

06 If a continuous flush median island formed by pavement markings separating travel in opposite directions is used, two sets of solid double yellow lines shall be used to form the island as shown in Figures 3B-2 and 3B-5. Other markings in the median island area shall also be yellow, except crosswalk markings which shall be white (see Section 3B.18).

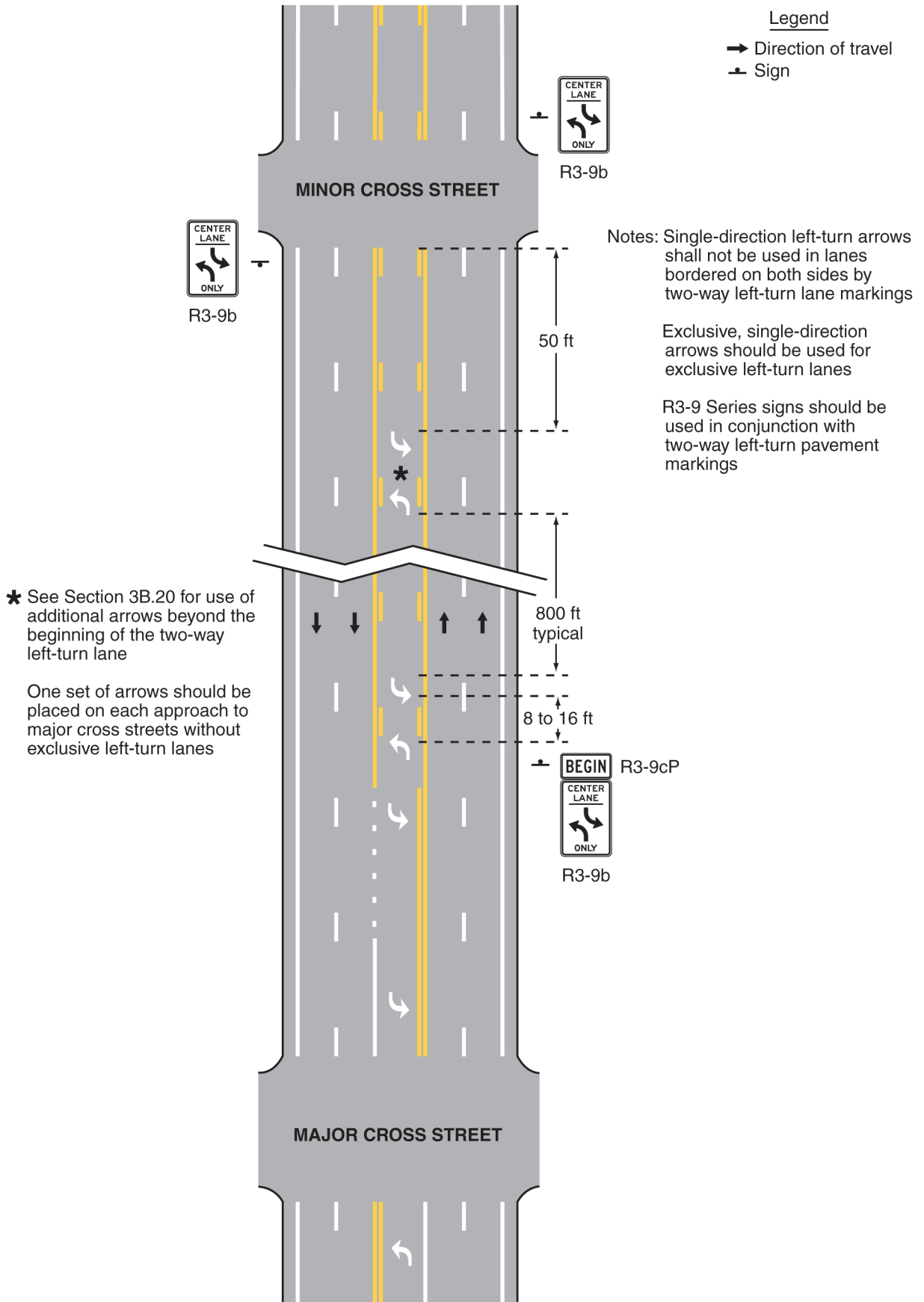
Guidance:

06A (DE Revision) A normal solid yellow edge line should be used adjacent to a raised median or flush median of contrasting color (see Figure 3B-2).

**Figure 3B-6. Example of Reversible Lane Marking Application**



**Figure 3B-7. Example of Two-Way Left-Turn Lane Marking Applications  
(Delaware Revision)**



## Section 3B.04 White Lane Line Pavement Markings and Warrants

### Standard:

01 **When used, lane line pavement markings delineating the separation of traffic lanes that have the same direction of travel shall be white.**

02 **Lane line markings shall be used on all freeways and Interstate highways.**

### Guidance:

03 *Lane line markings should be used on all roadways that are intended to operate with two or more adjacent traffic lanes in the same direction of travel, except as otherwise required for reversible lanes. Lane line markings should also be used at congested locations where the roadway will accommodate more traffic lanes with lane line markings than without the markings.*

### Support:

04 Examples of lane line markings are shown in Figures 3B-2, 3B-3, and 3B-7 through 3B-13.

### Standard:

05 **Except as provided in Paragraph 6, where crossing the lane line markings with care is permitted, the lane line markings shall consist of a normal broken white line.**

06 **A dotted white line marking shall be used as the lane line to separate a through lane that continues beyond the interchange or intersection from an adjacent lane for any of the following conditions:**

- A. A deceleration or acceleration lane,
- B. A through lane that becomes a mandatory exit or turn lane,
- C. An auxiliary lane 2 miles or less in length between an entrance ramp and an exit ramp, or
- D. An auxiliary lane 1 mile or less in length between two adjacent intersections.

### Guidance:

06A *(DE Revision) Dotted white line markings described in Paragraph 6 should be 10 inches wide along all state-maintained roadways.*

07 **(DE Revision) For exit ramps with a parallel deceleration lane, a dotted white lane line shall be installed from the upstream end of the full-width deceleration lane to the theoretical gore or to the upstream end of a solid white lane line, if used, that extends upstream from the theoretical gore as shown in Drawings A and C of Figures 3B-8 and 3B-8A.**

### Guidance:

08 *(DE Revision) For exit ramps with a parallel deceleration lane, a wide dotted white line extension should be installed in the taper area upstream from the full-width deceleration lane as shown in Drawings A and C of Figures 3B-8 and 3B-8A.*

09 *(DE Revision) For an exit ramp with a tapered deceleration lane, a wide dotted white line extension should be installed from the theoretical gore through the taper area such that it meets the edge line at the upstream end of the taper as shown in Drawing B of Figures 3B-8 and 3B-8A.*

### Standard:

10 **(DE Revision) For entrance ramps with a parallel acceleration lane, a dotted white lane line shall be installed from the theoretical gore or from the downstream end of a solid white lane line, if used, that extends downstream from the theoretical gore, to a point at least one-half the distance from the theoretical gore to the downstream end of the acceleration taper, as shown in Drawing A of Figures 3B-9 and 3B-9A.**

### Guidance:

10A *(DE Revision) Dotted white lane line markings described in Paragraph 10 should be 10 inches wide along all state-maintained roadways.*

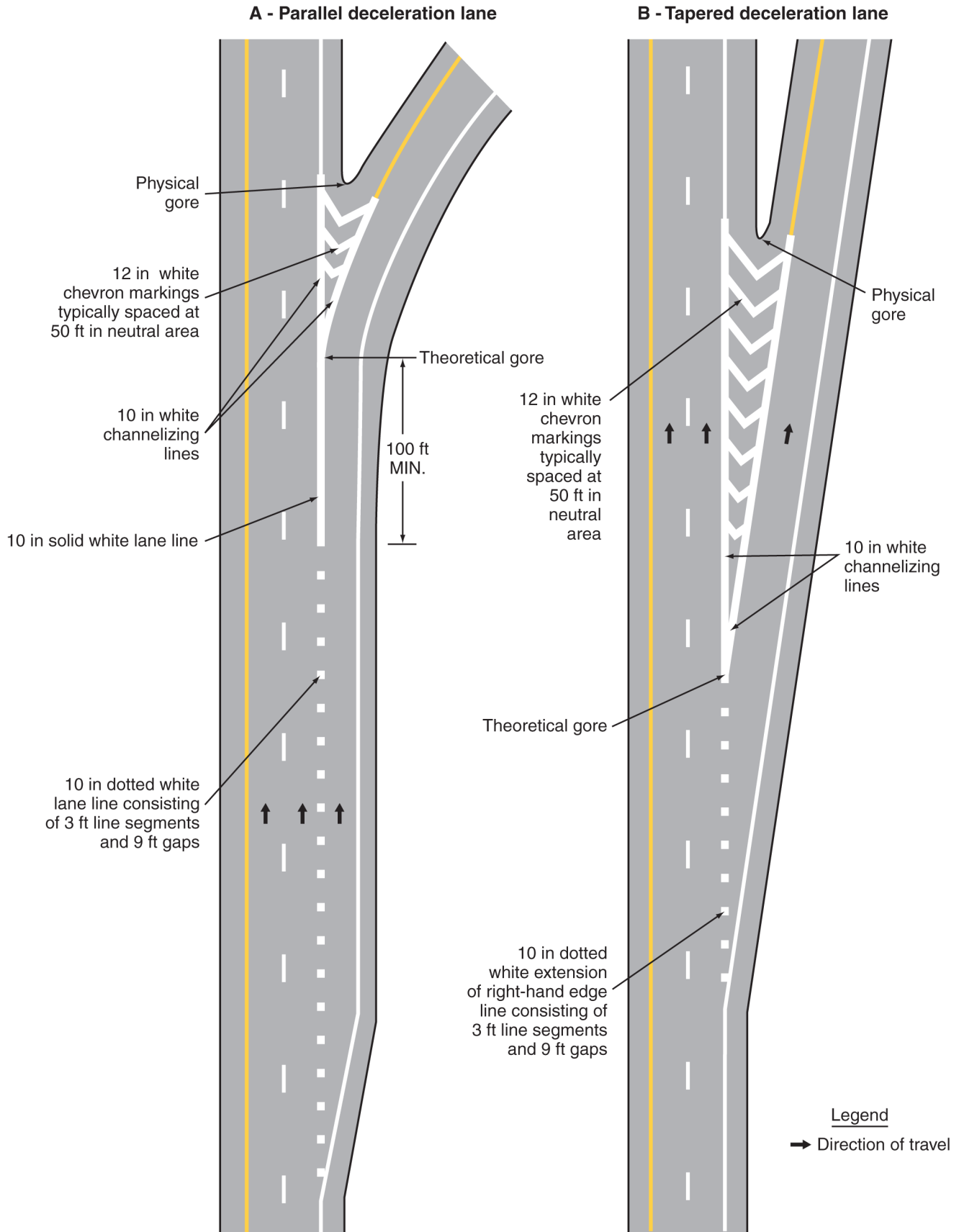
### Option:

11 *(DE Revision) Paragraph deleted.*

12 *(DE Revision) Paragraph deleted.*

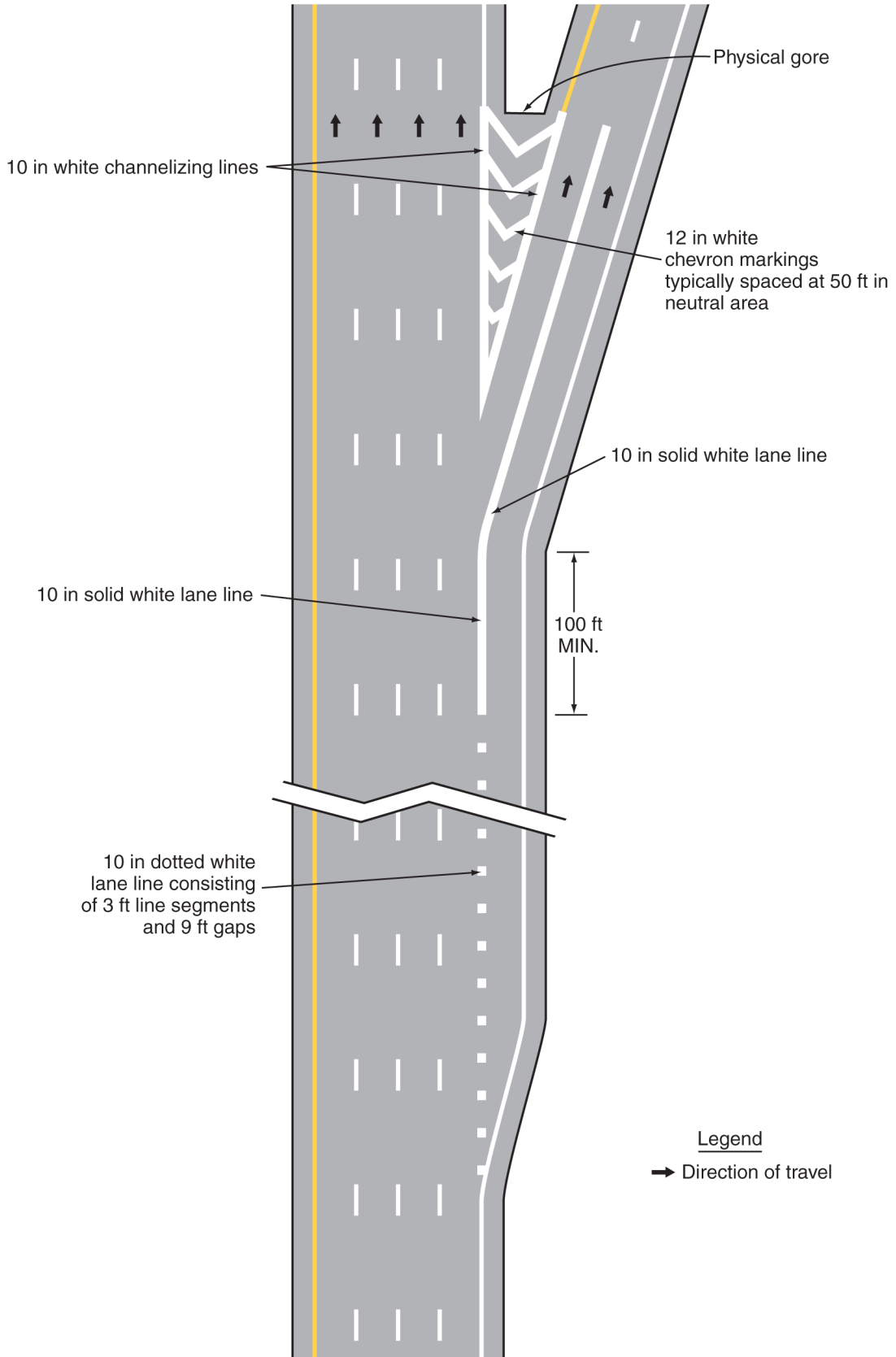


**Figure 3B-8. Examples of Dotted Line and Channelizing Line Applications for Exit Ramp Markings along Interstates, Freeways and Expressways (Sheet 1 of 2) (Delaware Revision)**

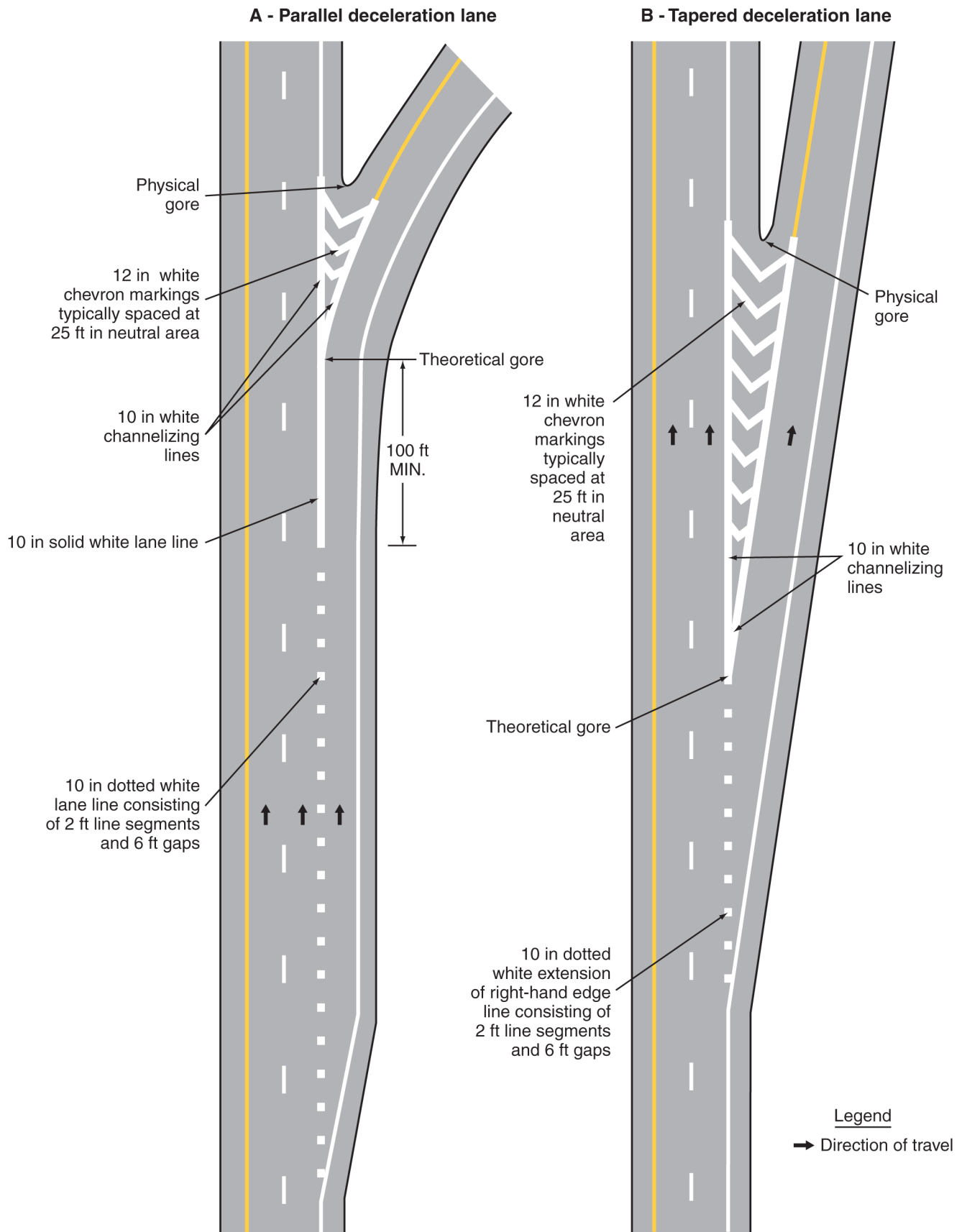


**Figure 3B-8. Examples of Dotted Line and Channelizing Line Applications for Exit Ramp Markings along Interstates, Freeways and Expressways (Sheet 2 of 2)**  
**(Delaware Revision)**

**C – Parallel deceleration lane at a multi-lane exit ramp having an optional exit lane that also carries the through route**

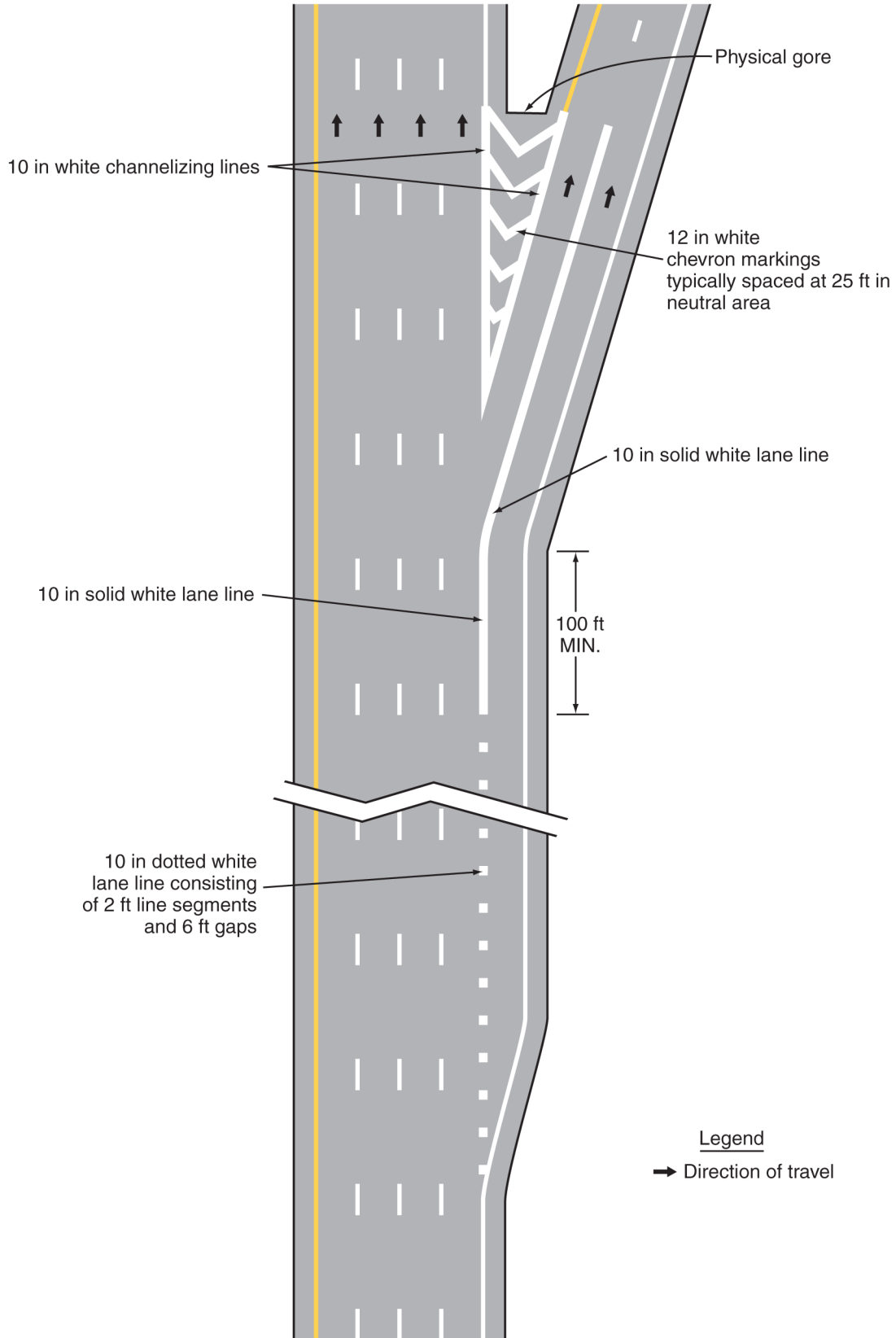


**Figure 3B-8A. Examples of Dotted Line and Channelizing Line Applications for Exit Ramp Markings along All Other Roads (Non-Interstates, Freeways and Expressways) (Sheet 1 of 2) (Delaware Revision)**

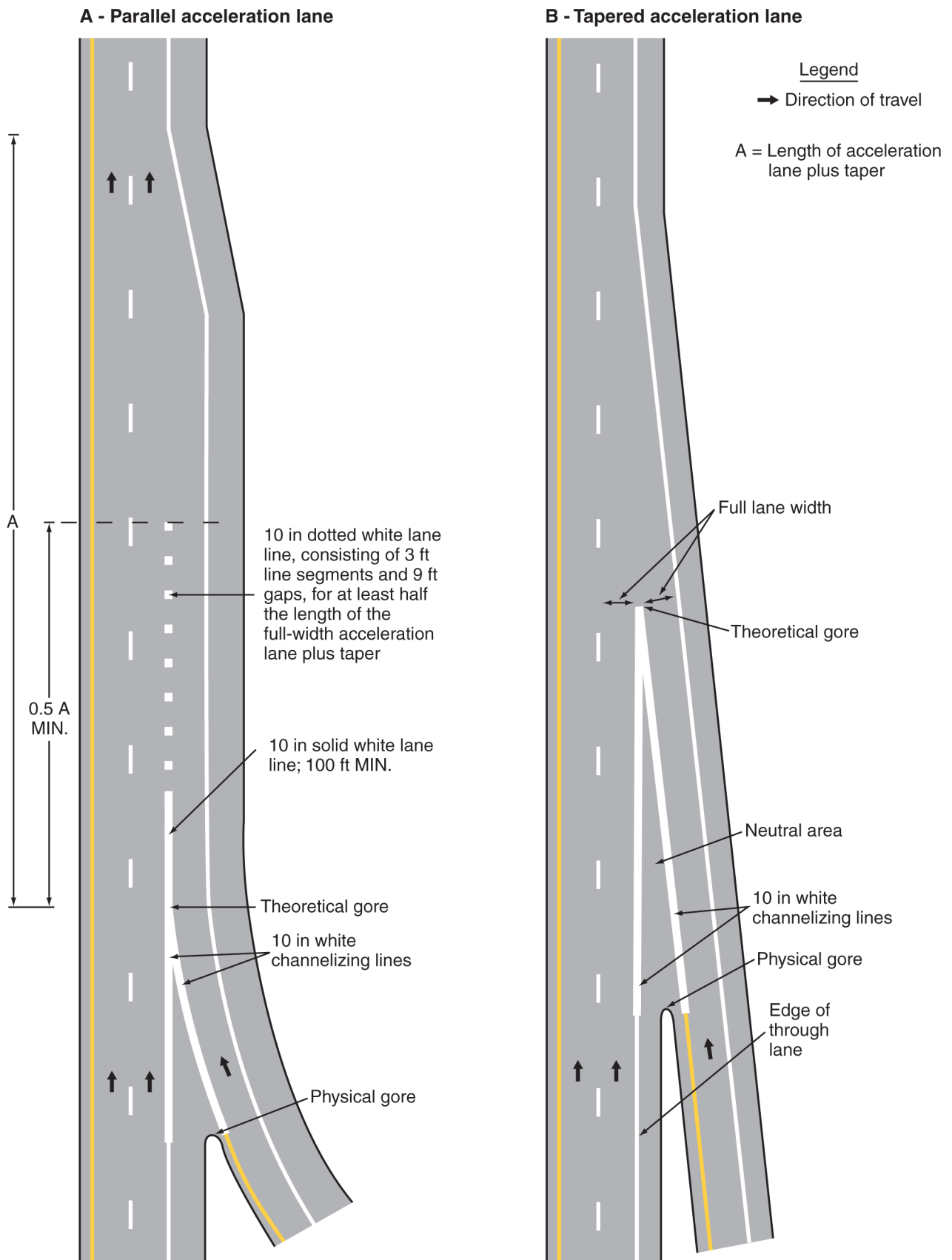


**Figure 3B-8A. Examples of Dotted Line and Channelizing Line Applications for Exit Ramp Markings along All Other Roads (Non-Interstates, Freeways and Expressways) (Sheet 2 of 2)**  
**(Delaware Revision)**

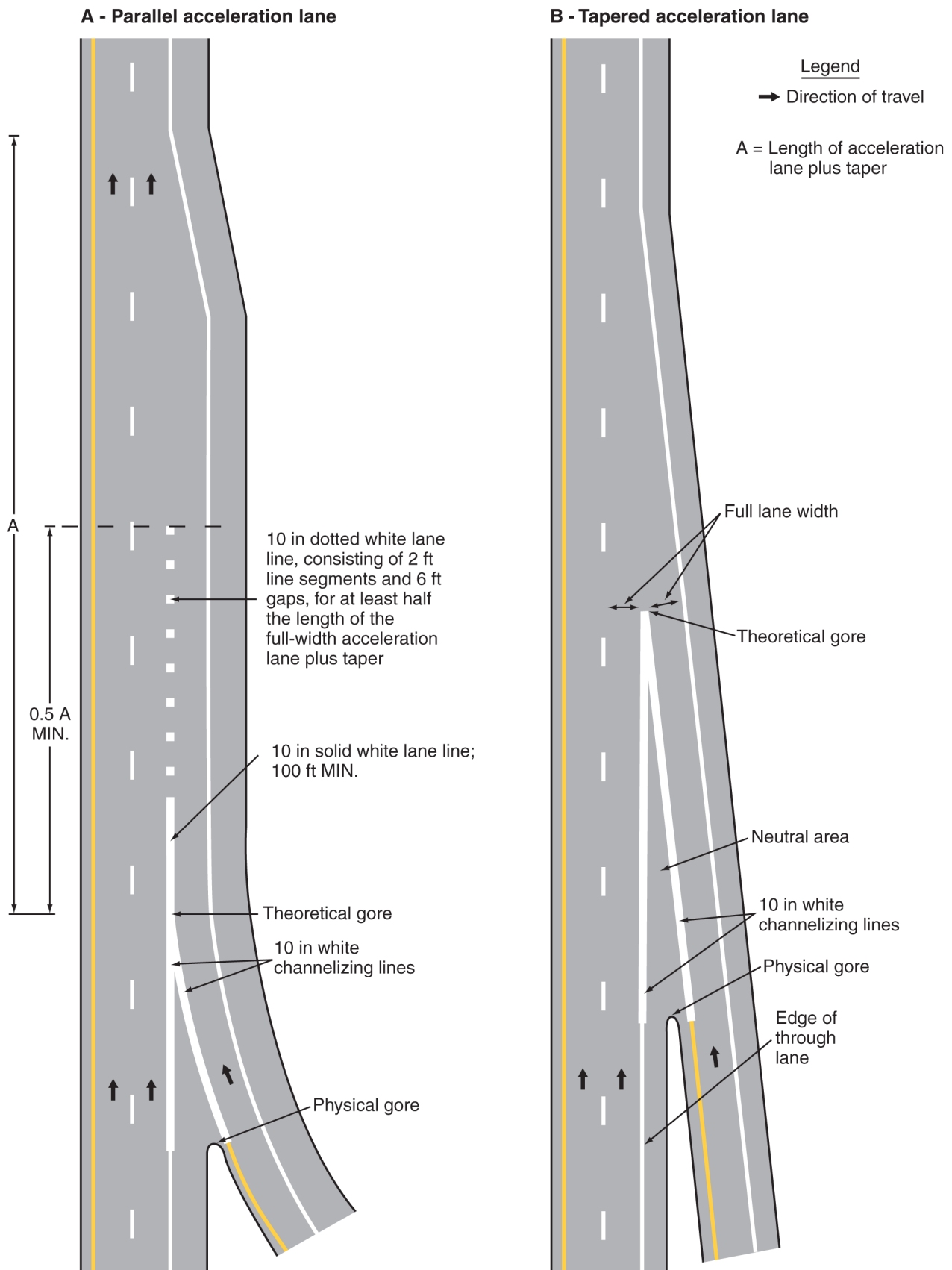
**C – Parallel deceleration lane at a multi-lane exit ramp having an optional exit lane that also carries the through route**



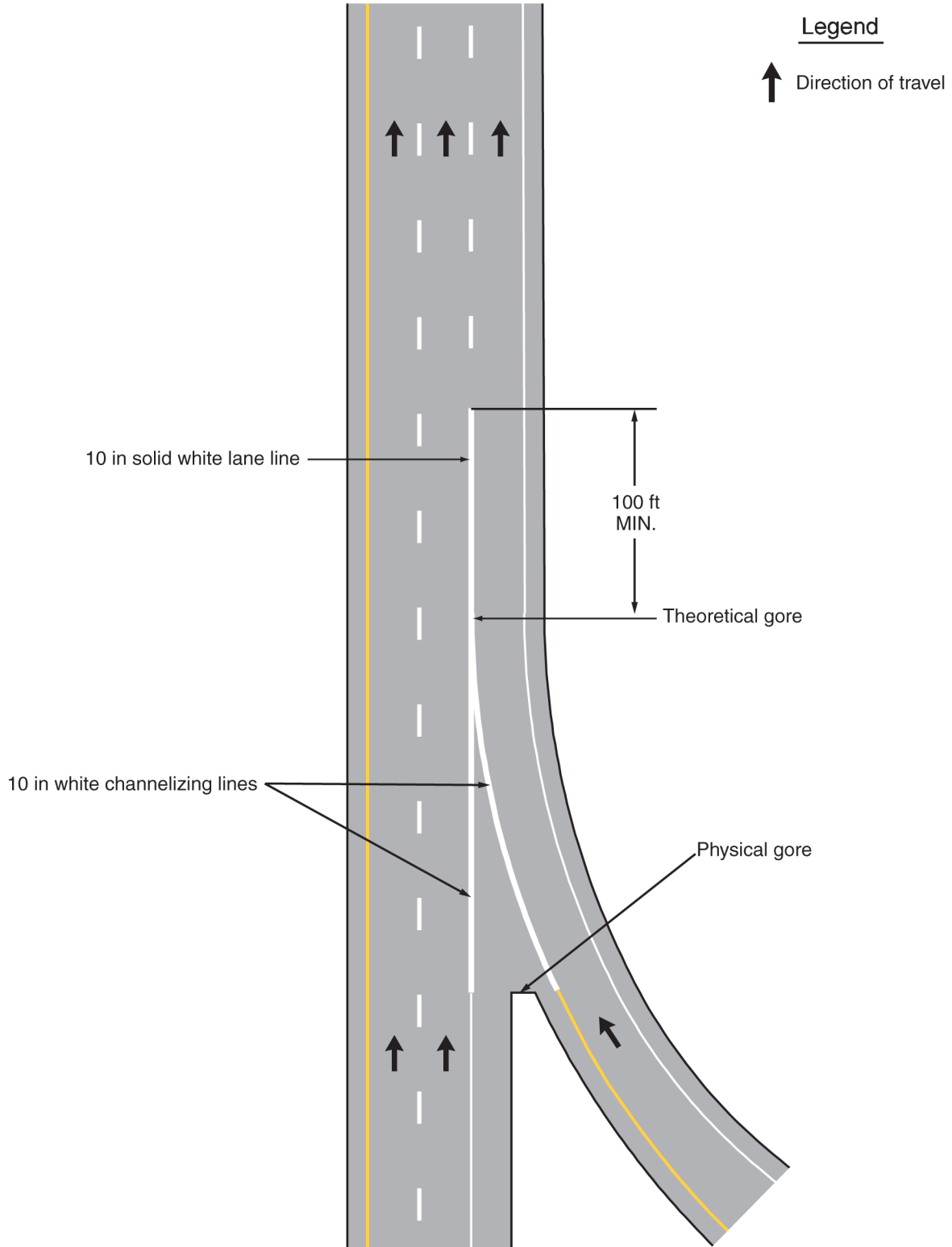
**Figure 3B-9. Examples of Dotted Line and Channelizing Line Applications for Entrance Ramp Markings along Interstates, Freeways and Expressways (Delaware Revision)**



**Figure 3B-9A. Examples of Dotted Line and Channelizing Line Applications for Entrance Ramp Markings along All Other Roads (Non-Interstates, Freeways and Expressways) (Delaware Revision)**



**Figure 3B-9B. Example of Channelizing Line Application for Added Lane Entrance Ramp  
(Delaware Revision)**



**Standard:**

- 13 **(DE Revision)** A wide dotted white lane line shall be used:
- A. As a lane drop marking in advance of lane drops at exit ramps to distinguish a lane drop from a normal exit ramp (see Drawings A, B, and C of Figures 3B-10 and 3B-10A),
  - B. In advance of route splits with dedicated lanes (see Drawing D of Figures 3B-10 and 3B-10A),
  - C. To separate a through lane that continues beyond an interchange from an adjacent auxiliary lane between an entrance ramp and an exit ramp (see Drawing E of Figures 3B-10 and 3B-10A),
  - D. As a lane drop marking in advance of lane drops at intersections to distinguish a lane drop from an intersection through lane (see Drawings A and B of Figure 3B-11), and
  - E. To separate a through lane that continues beyond an intersection from an adjacent auxiliary lane between two intersections (see Drawing C of Figure 3B-11).

*Guidance:*

- 14 **(DE Revision)** Lane drop markings used in advance of lane drops at *interstate, freeway and expressway exit ramps* should begin at least 1/2 mile in advance of the theoretical gore. *Markings for lane addition entrance ramps should be installed as shown in Figure 3B-9B.*
- 15 *On the approach to a multi-lane exit ramp having an optional exit lane that also carries through traffic, lane line markings should be used as illustrated in Drawing B of Figure 3B-10. In this case, if the right-most exit lane is an added lane such as a parallel deceleration lane, the lane drop marking should begin at the upstream end of the full-width deceleration lane, as shown in Drawing C of Figure 3B-8.*
- 16 *Lane drop markings used in advance of lane drops at intersections should begin a distance in advance of the intersection that is determined by engineering judgment as suitable to enable drivers who do not desire to make the mandatory turn to move out of the lane being dropped prior to reaching the queue of vehicles that are waiting to make the turn. The lane drop marking should begin no closer to the intersection than the most upstream regulatory or warning sign associated with the lane drop.*
- 17 **(DE Revision)** *Along interstates, freeways, and expressways, the dotted white lane lines that are used for lane drop markings and that are used as a lane line separating through lanes from auxiliary lanes should consist of line segments that are 3 feet in length separated by 9-foot gaps. Along all other roadways, the dotted white lane lines that are used for lane drop markings and that are used as a lane line separating through lanes from auxiliary lanes should consist of line segments that are 2 feet in length separated by 6-foot gaps.*

*Support:*

- 18 Section 3B.20 contains information regarding other markings that are associated with lane drops, such as lane-use arrow markings and ONLY word markings.
- 19 Section 3B.09 contains information about the lane line markings that are to be used for transition areas where the number of through lanes is reduced.

**Standard:**

- 20 **Where crossing the lane line markings is discouraged, the lane line markings shall consist of a normal or wide solid white line.**

*Option:*

- 21 Where it is intended to discourage lane changing on the approach to an exit ramp, a wide solid white lane line may extend upstream from the theoretical gore or, for multi-lane exits, as shown in Drawing B of Figure 3B-10, for a distance that is determined by engineering judgment.
- 22 Where lane changes might cause conflicts, a wide or normal solid white lane line may extend upstream from an intersection.
- 23 In the case of a lane drop at an exit ramp or intersection, such a solid white line may replace a portion, but not all of the length of the wide dotted white lane line.

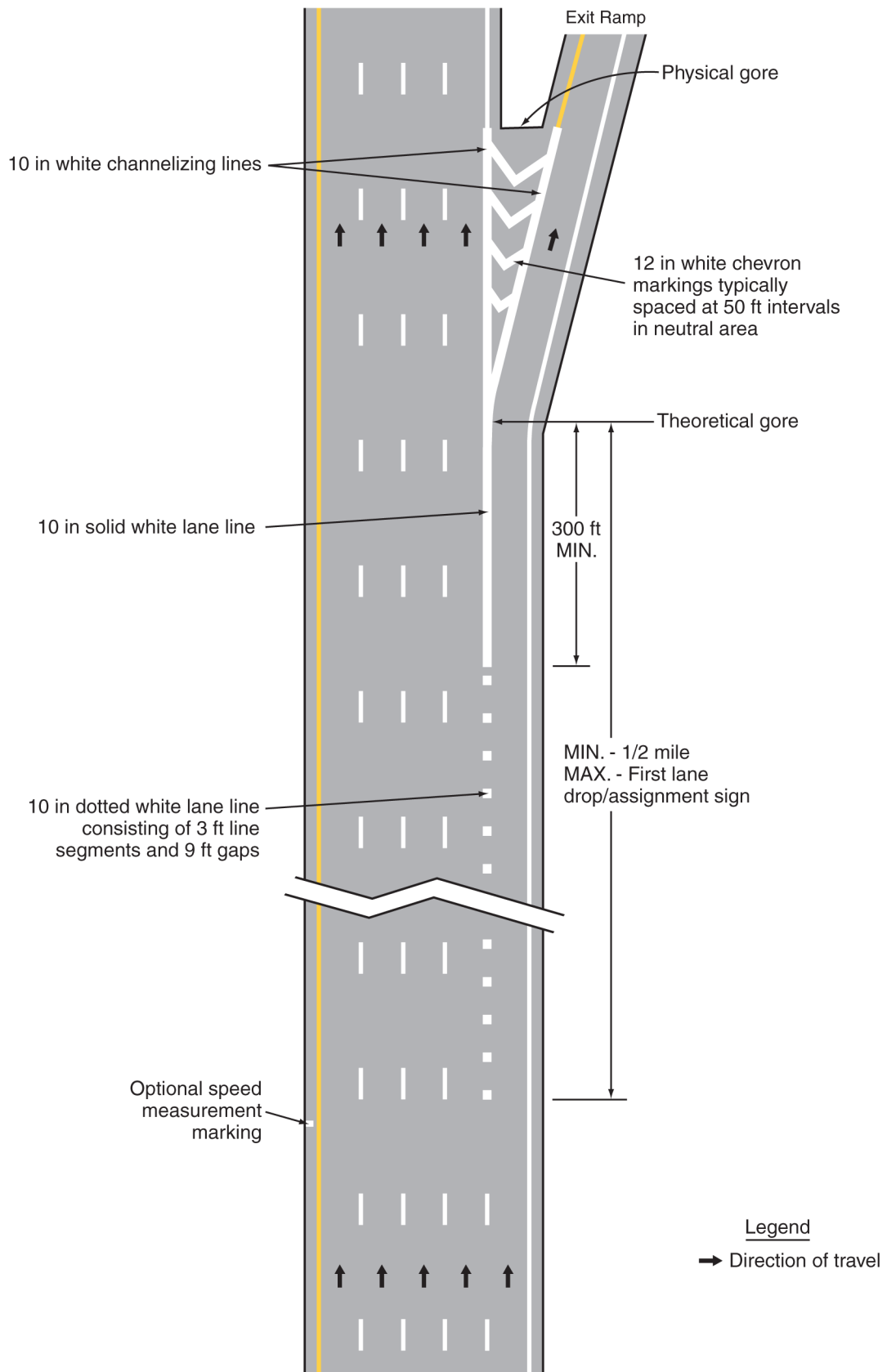
*Support:*

- 24 Section 3B.09 contains information about the lane line markings that are to be used for transition areas where the number of through lanes is reduced.



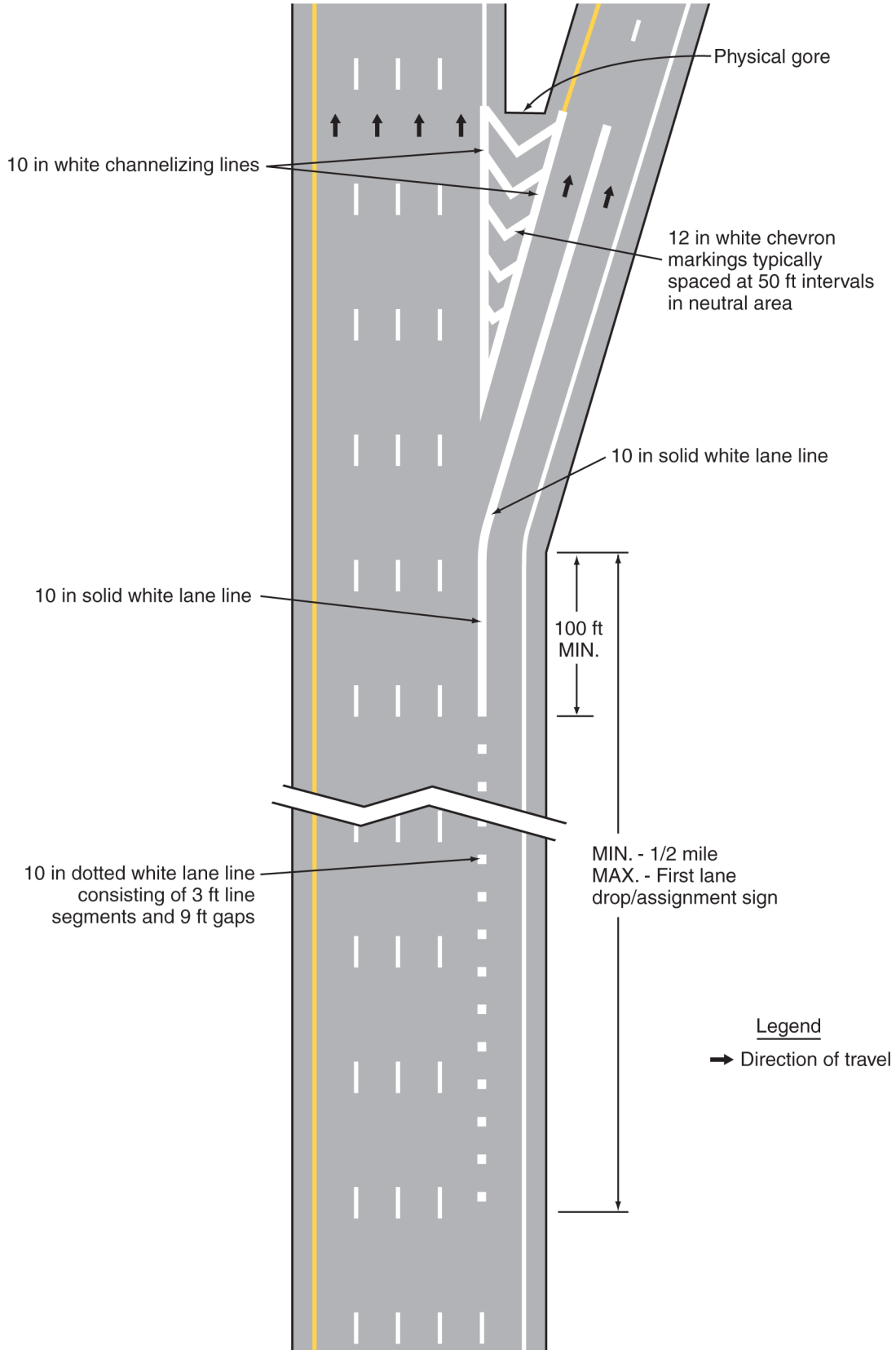
**Figure 3B-10. Examples of Applications of Interstate, Freeway and Expressway Lane-Drop Markings (Sheet 1 of 5)  
(Delaware Revision)**

**A – Lane drop at a single lane exit ramp**

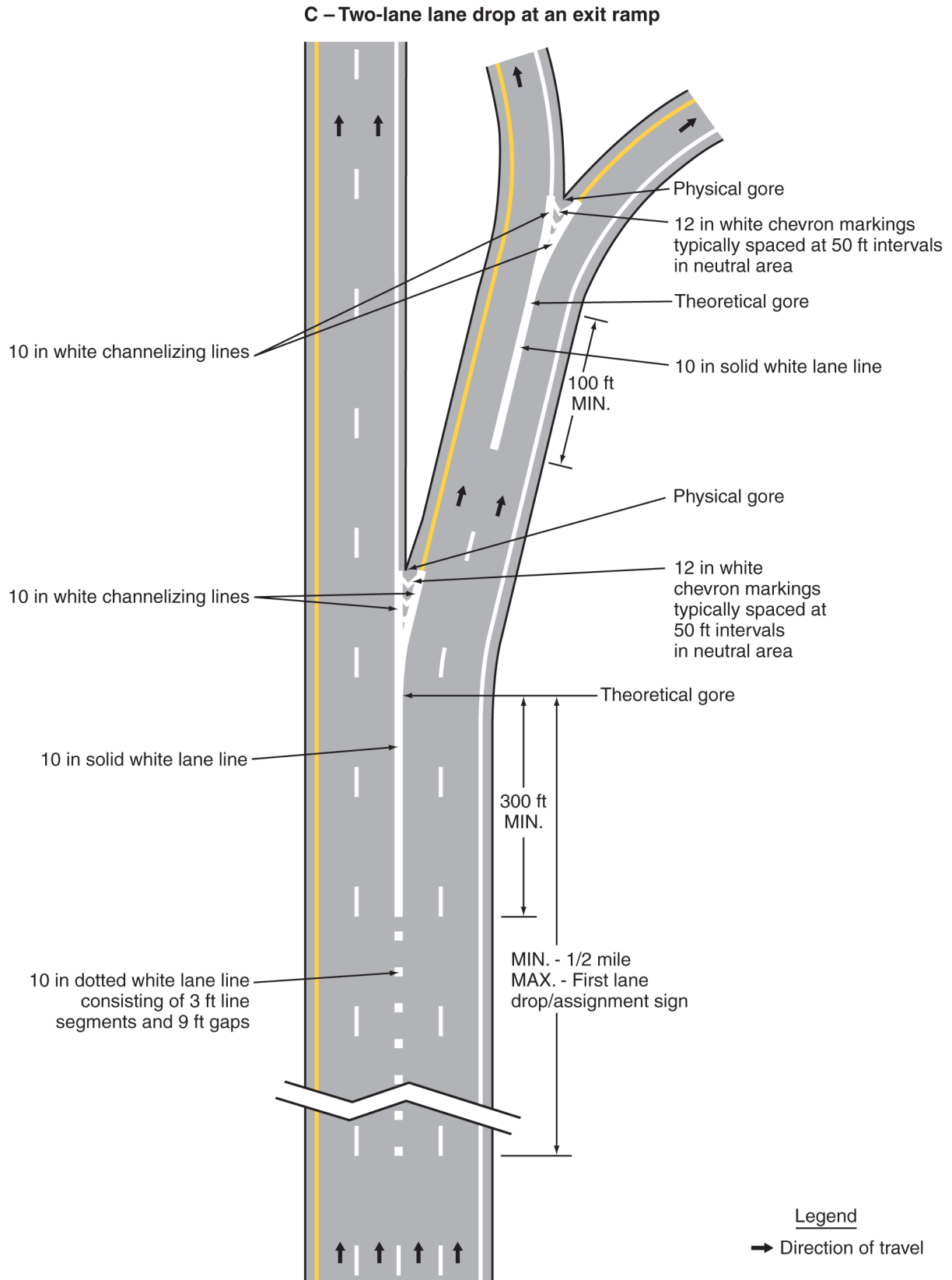


### Figure 3B-10. Examples of Applications of Interstate, Freeway and Expressway Lane-Drop Markings (Sheet 2 of 5) (Delaware Revision)

**B – Lane drop at a multi-lane exit ramp having an optional exit lane that also carries the through route**

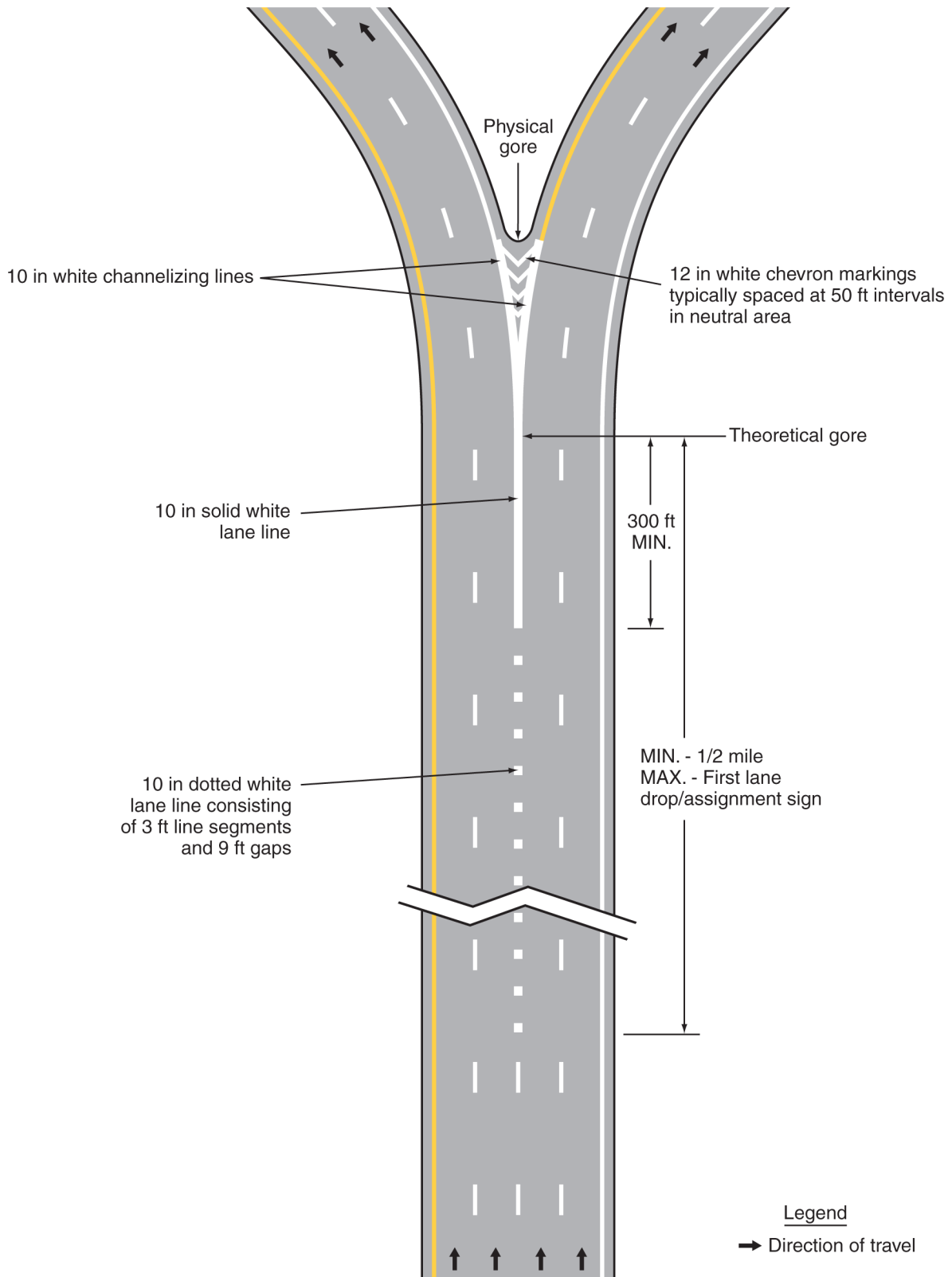


**Figure 3B-10. Examples of Applications of Interstate, Freeway and Expressway Lane-Drop Markings (Sheet 3 of 5)  
(Delaware Revision)**

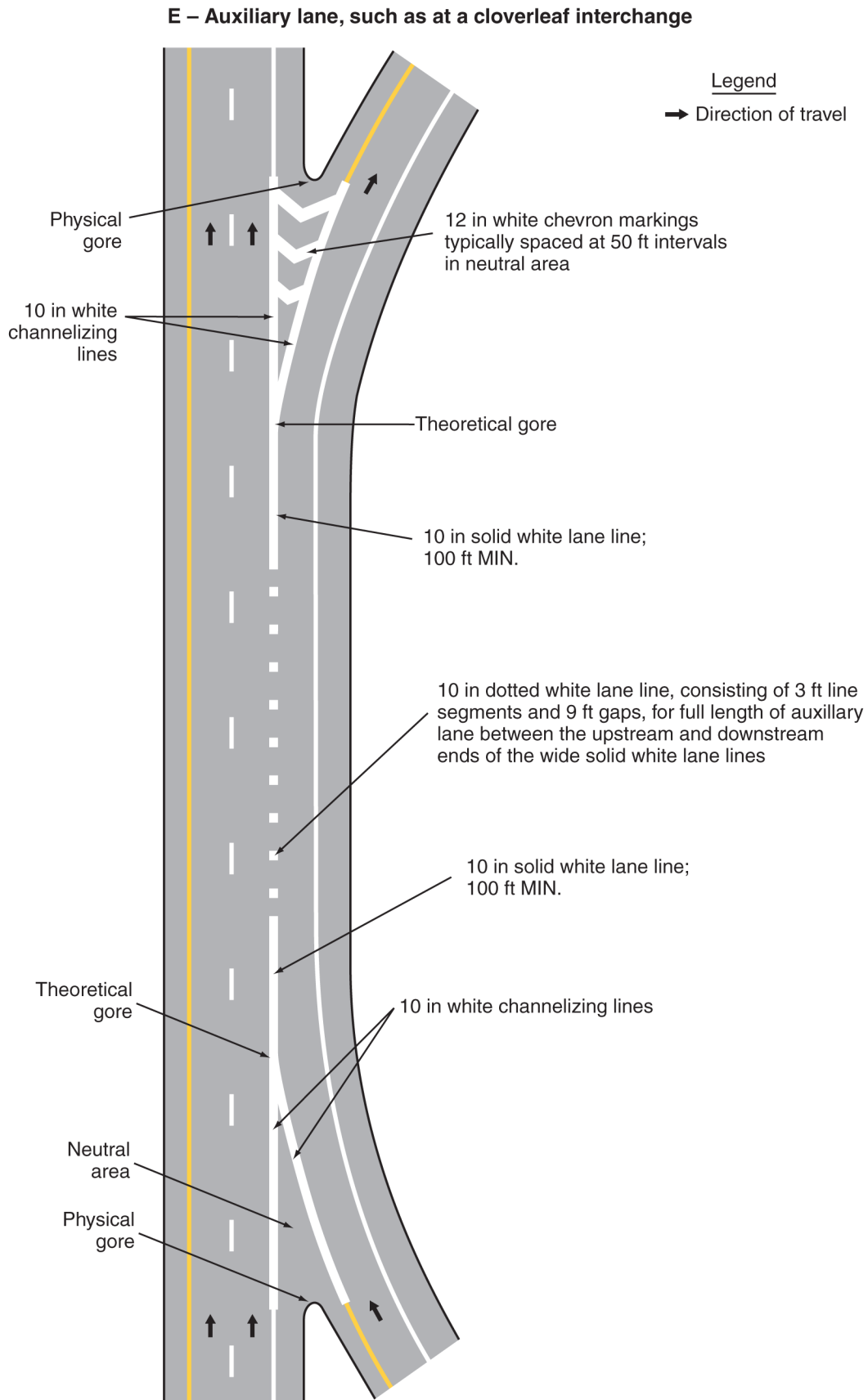


**Figure 3B-10. Examples of Applications of Interstate, Freeway and Expressway Lane-Drop Markings (Sheet 4 of 5)**  
**(Delaware Revision)**

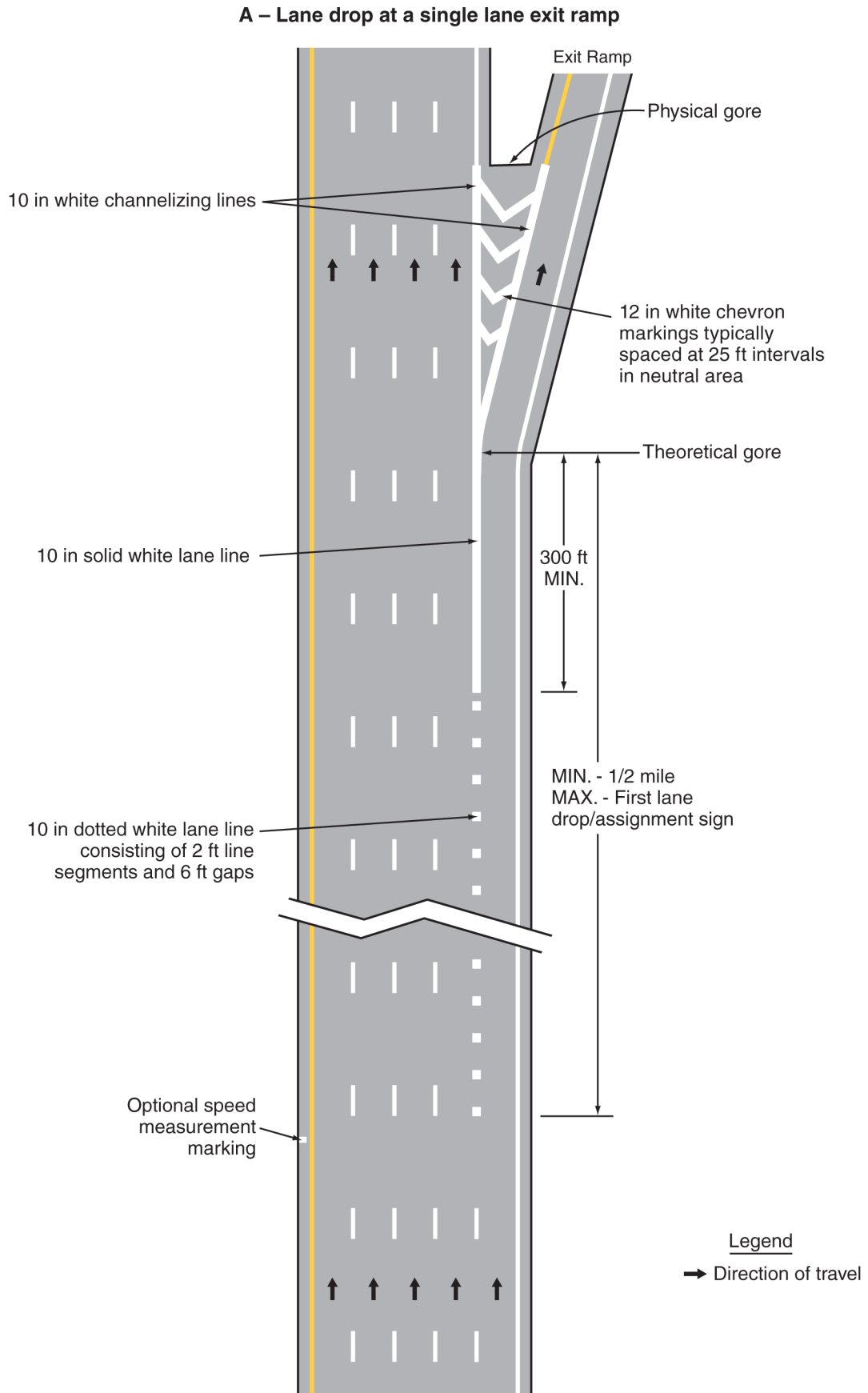
**D – Route split with dedicated lanes**



**Figure 3B-10. Examples of Applications of Interstate, Freeway and Expressway Lane-Drop Markings (Sheet 5 of 5)  
(Delaware Revision)**

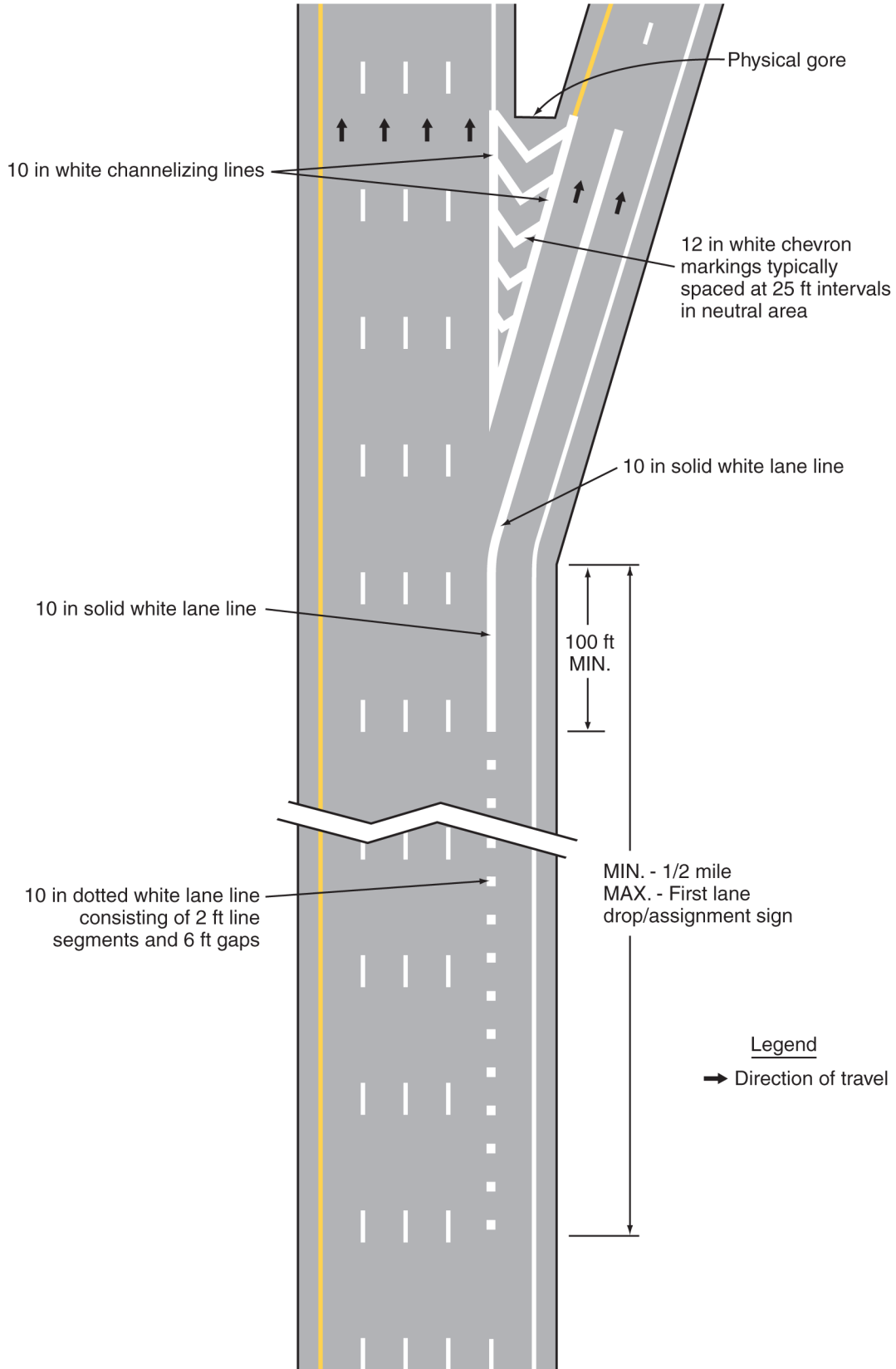


**Figure 3B-10A. Examples of Applications of Lane-Drop Markings along All Other Roads (Non-Interstates, Freeways and Expressways) (Sheet 1 of 5)**  
**(Delaware Revision)**



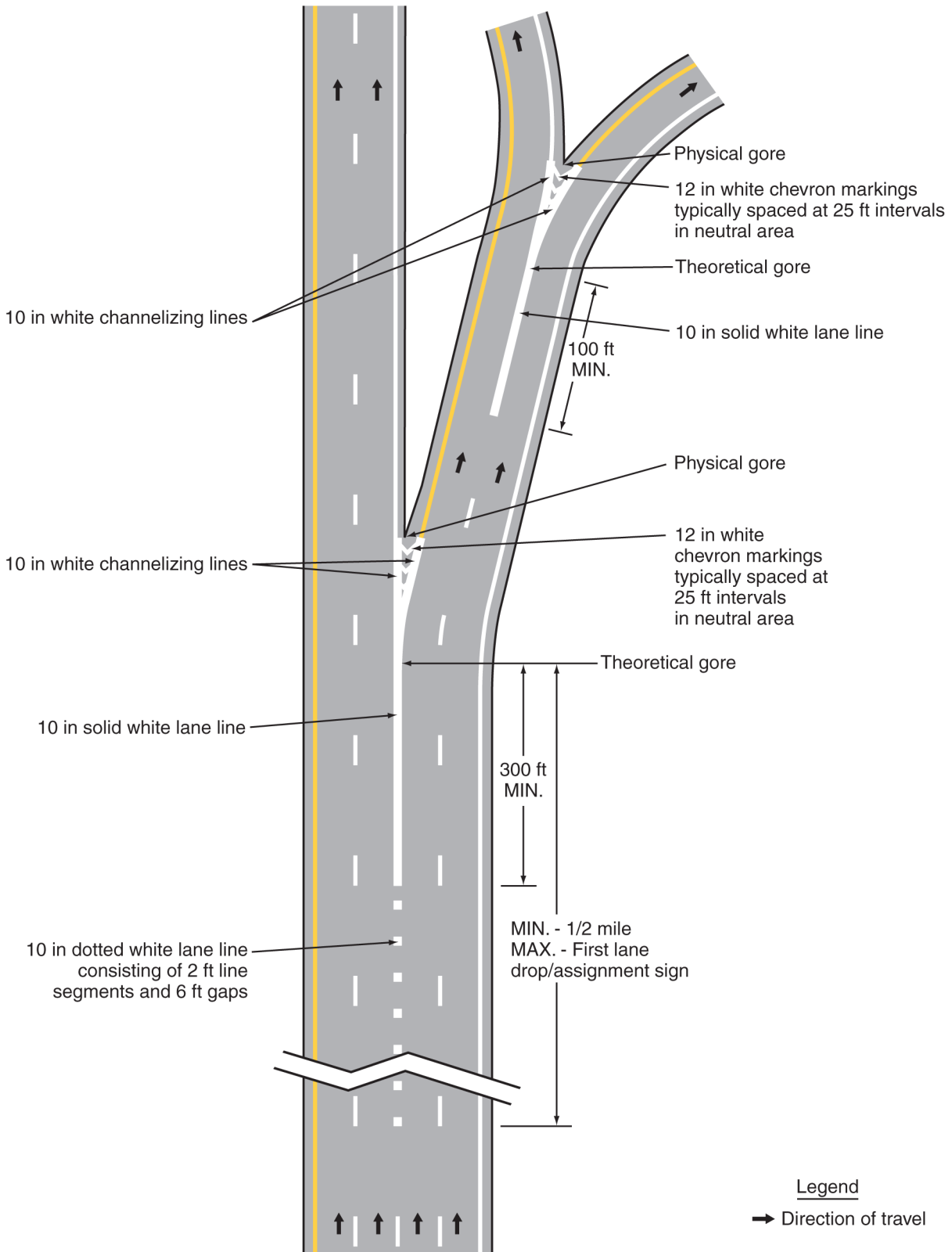
**Figure 3B-10A. Examples of Applications of Lane-Drop Markings along All Other Roads (Non-Interstates, Freeways and Expressways) (Sheet 2 of 5)**  
**(Delaware Revision)**

**B – Lane drop at a multi-lane exit ramp having an optional exit lane that also carries the through route**



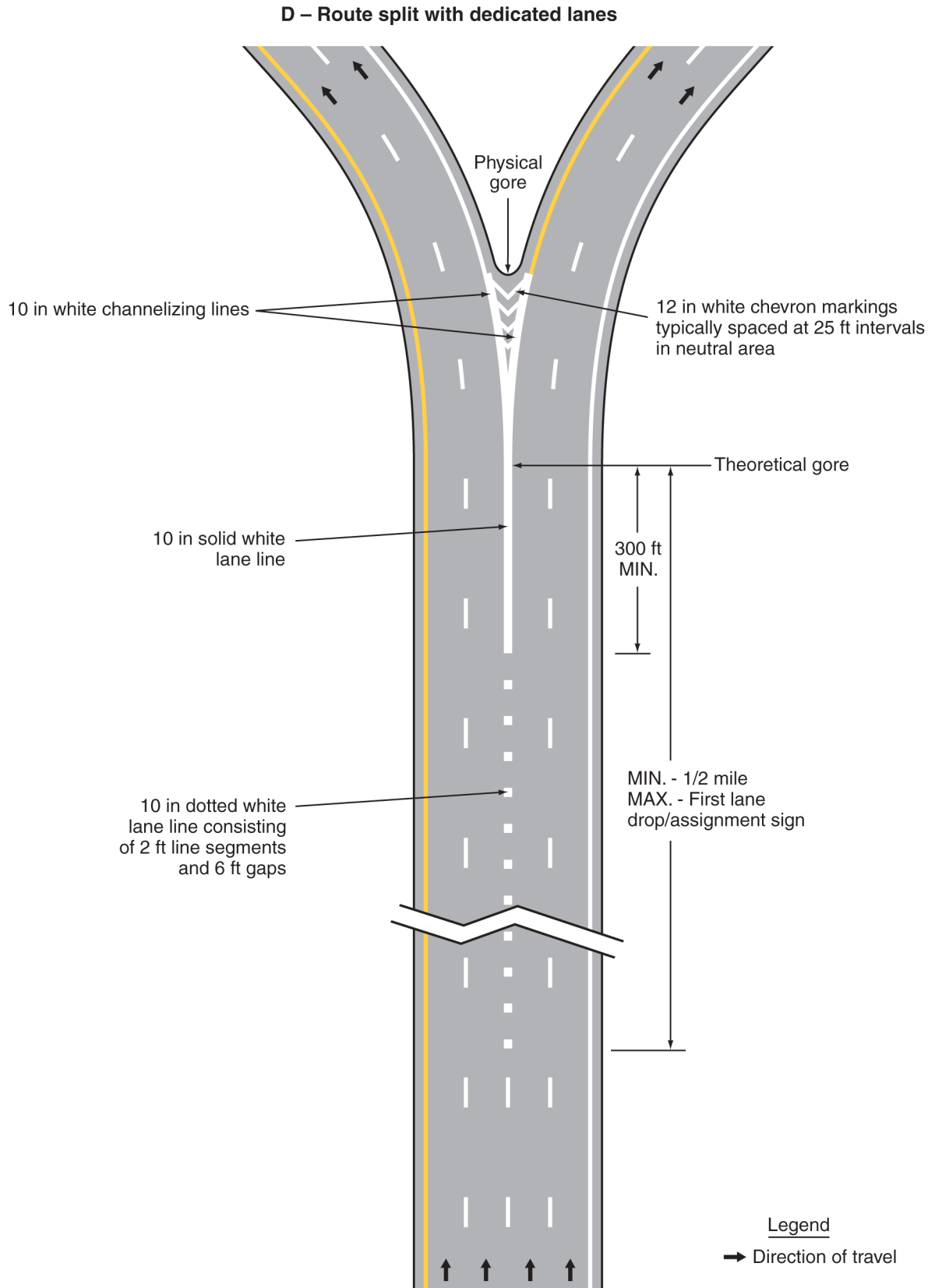
**Figure 3B-10A. Examples of Applications of Lane-Drop Markings along All Other Roads (Non-Interstates, Freeways and Expressways) (Sheet 3 of 5)**  
**(Delaware Revision)**

**C – Two-lane lane drop at an exit ramp**

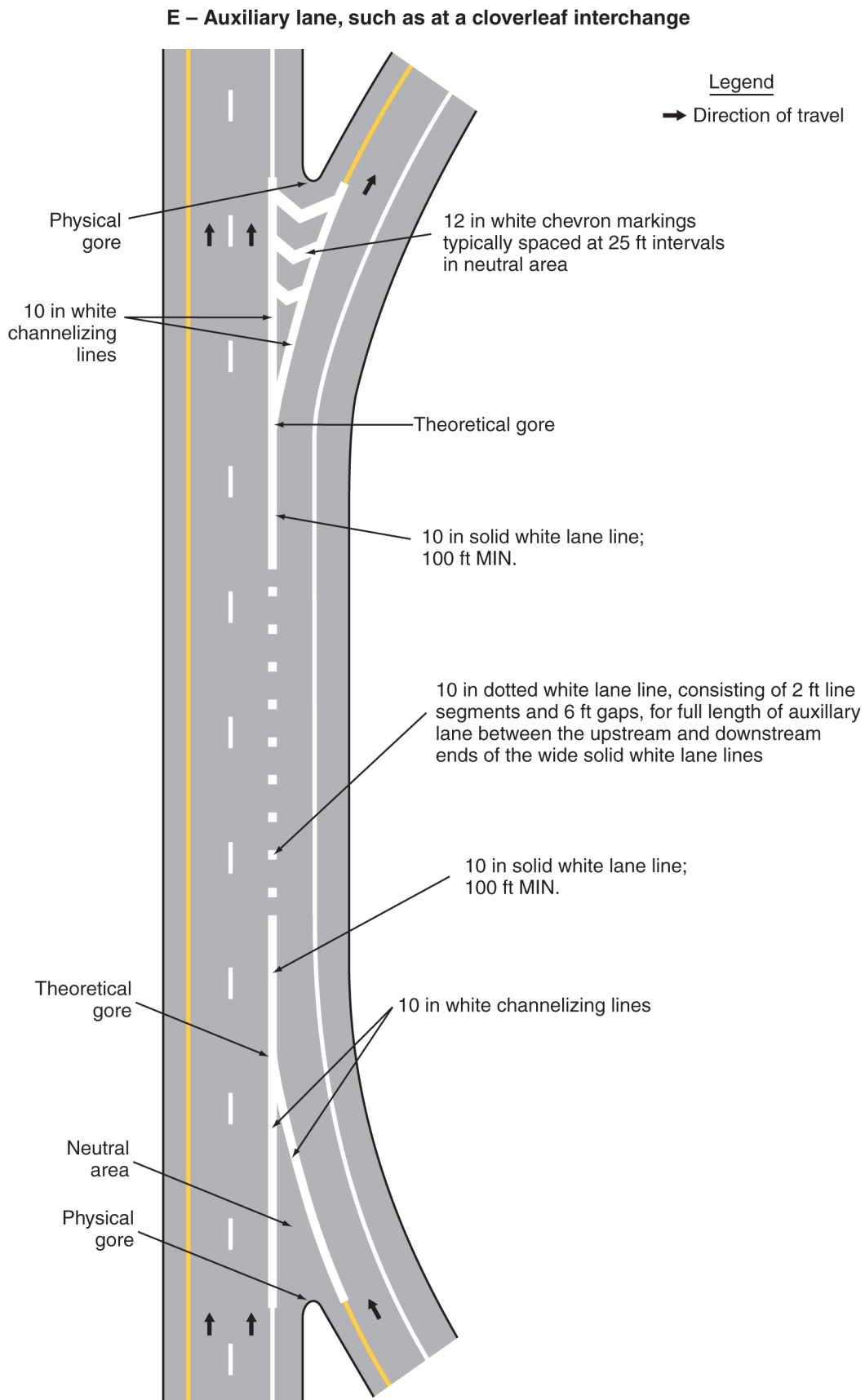




**Figure 3B-10A. Examples of Applications of Lane-Drop Markings along All Other Roads (Non-Interstates, Freeways and Expressways) (Sheet 4 of 5)**  
**(Delaware Revision)**

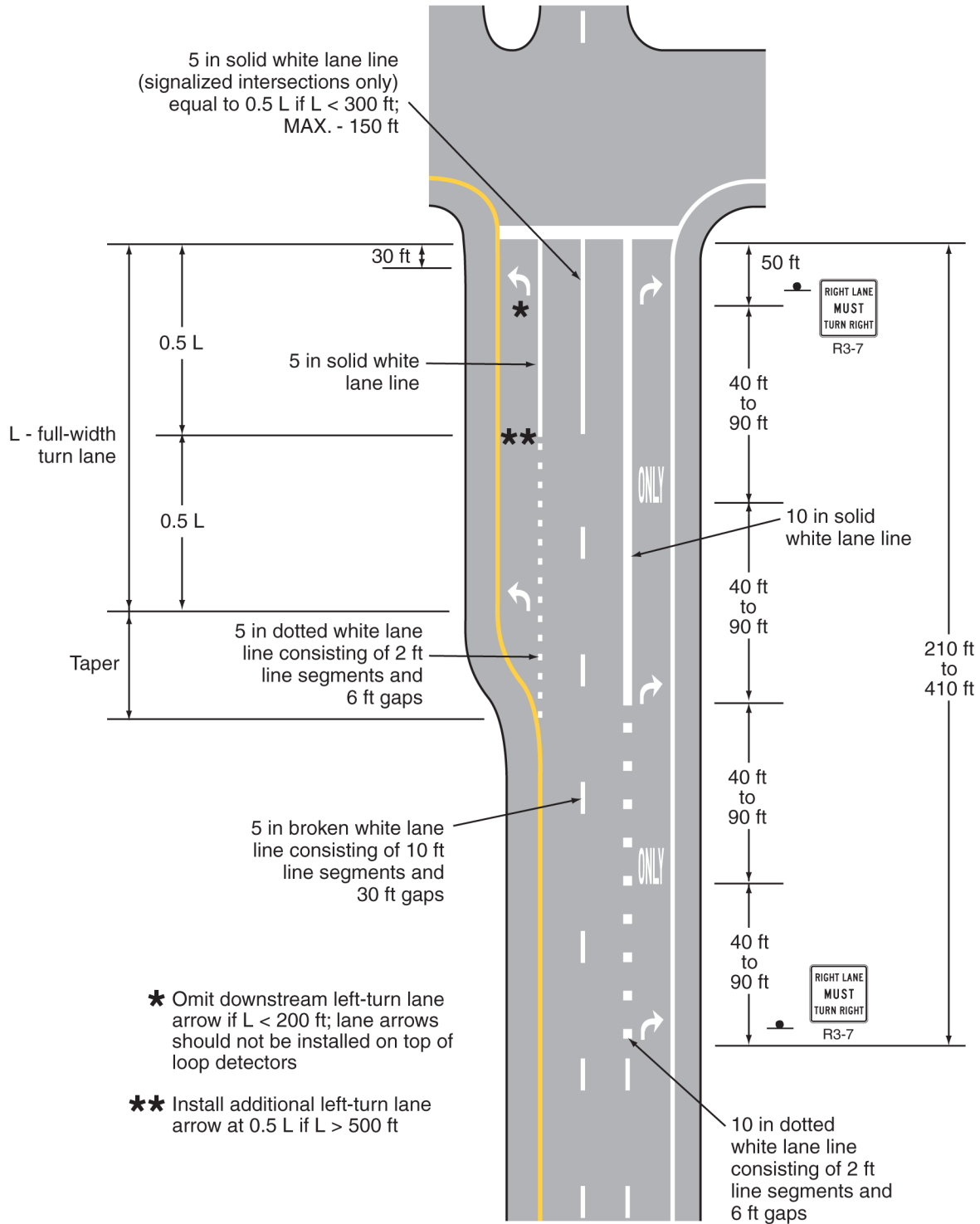


**Figure 3B-10A. Examples of Applications of Lane-Drop Markings along All Other Roads (Non-Interstates, Freeways and Expressways) (Sheet 5 of 5) (Delaware Revision)**



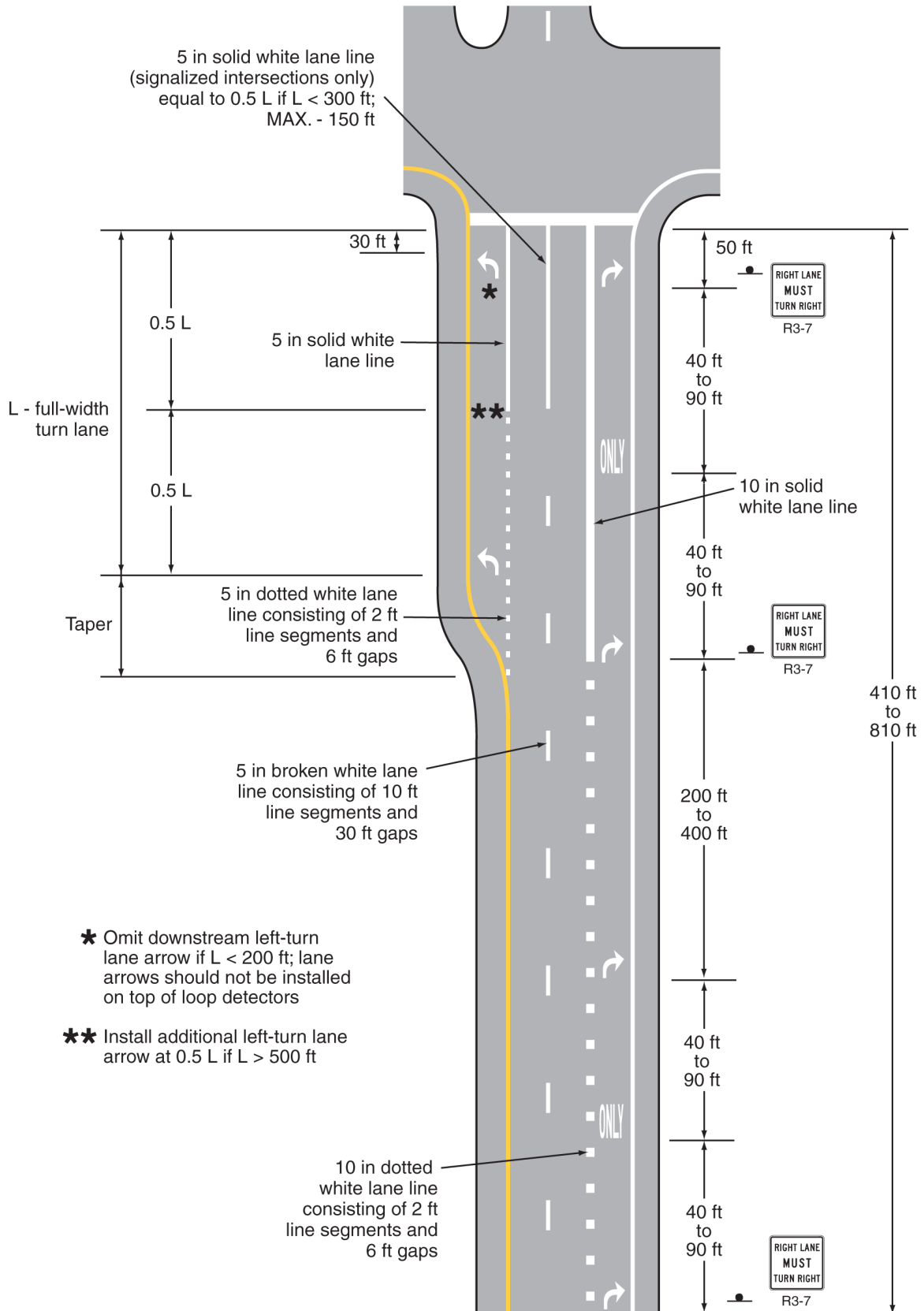
**Figure 3B-11. Examples of Applications of Conventional Road Auxiliary Lane and Lane-Drop Markings (Sheet 1 of 5)**  
**(Delaware Revision)**

**A – Right-turn lane drop at an intersection**  
**(Posted or 85th-percentile speed < 35 MPH)**



**Figure 3B-11. Examples of Applications of Conventional Road Auxiliary Lane and Lane-Drop Markings (Sheet 2 of 5)**  
**(Delaware Revision)**

**B – Right-turn lane drop at an intersection**  
**(Posted or 85th-percentile speed  $\geq$  35 MPH)**

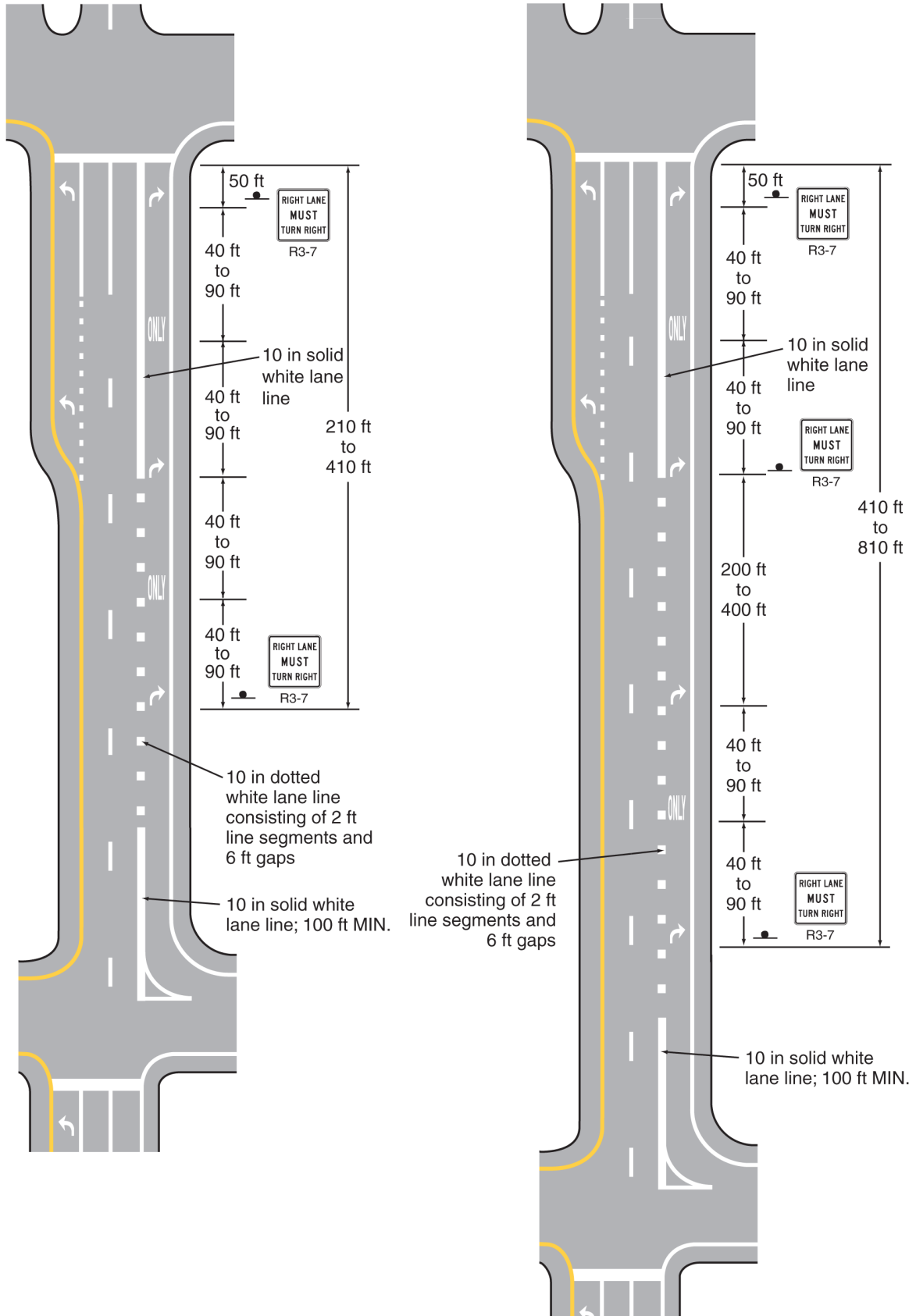


**Figure 3B-11. Examples of Applications of Conventional Road Auxiliary Lane and Lane-Drop Markings (Sheet 3 of 5)**  
**(Delaware Revision)**

**C – Auxiliary lane between intersections**

Posted or 85th-percentile speed < 35 MPH

Posted or 85th-percentile speed ≥ 35 MPH

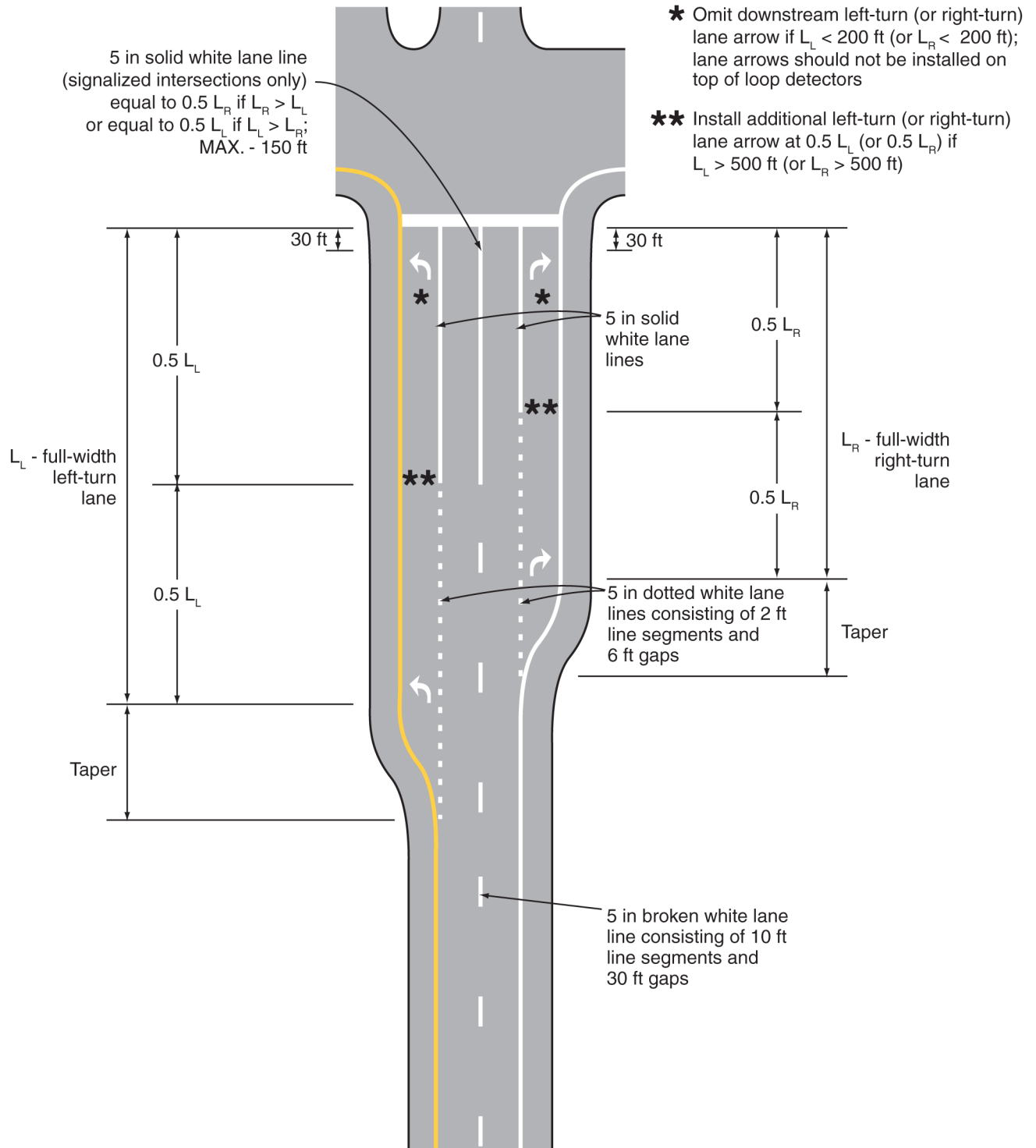


**Figure 3B-11. Examples of Applications of Conventional Road Auxiliary Lane and Lane-Drop Markings**

(Sheet 4 of 5)

**(Delaware Revision)**

**D – Exclusive turn lanes at an intersection**

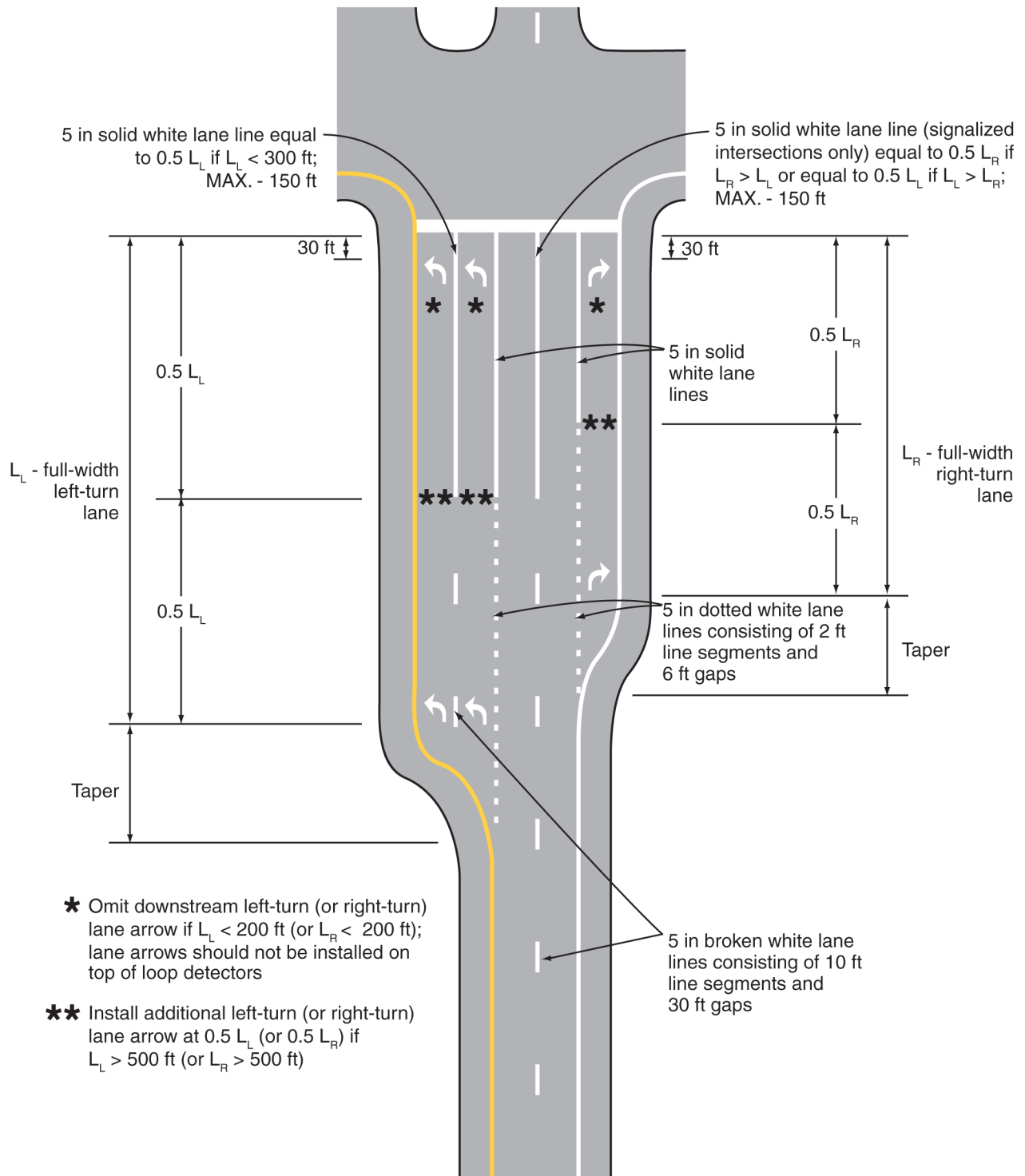


**Figure 3B-11. Examples of Applications of Conventional Road Auxiliary Lane and Lane-Drop Markings**

(Sheet 5 of 5)

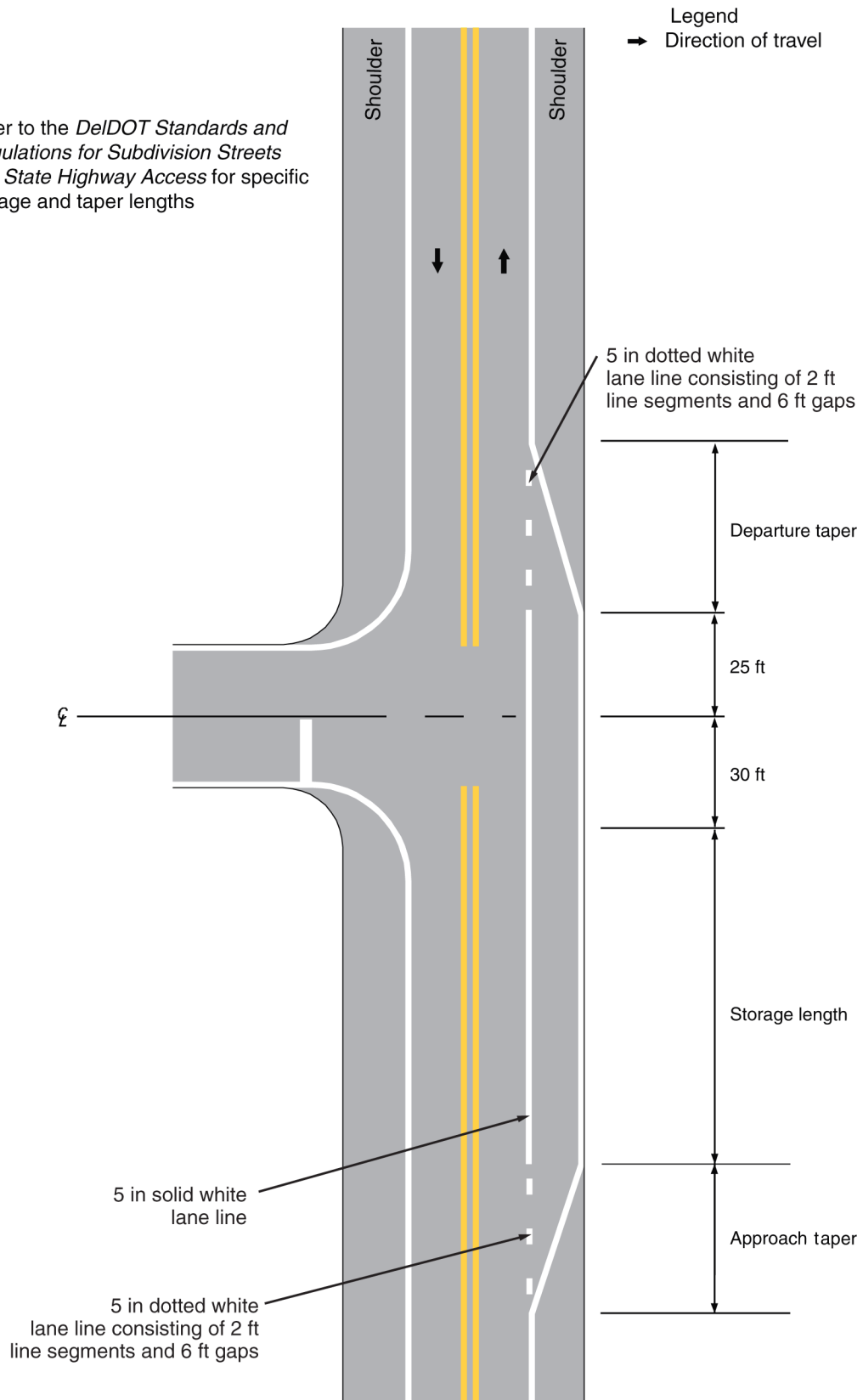
**(Delaware Revision)**

**E – Two left-turn lanes at an intersection**



**Figure 3B-11A. Example of Auxiliary Lane Lines - Bypass Lane  
(Delaware Revision)**

Note: Refer to the *DeIDOT Standards and Regulations for Subdivision Streets and State Highway Access* for specific storage and taper lengths





*Guidance:*

25 *(DE Revision)* On approaches to intersections, a solid white lane line marking should be used to separate a through lane from an added mandatory turn lane. The length of the solid white lane line should be one-half the length of the full-width mandatory turn lane (see Figure 3B-11).

26 *(DE Revision)* On approaches to *signalized* intersections, solid white lane line markings should be used to separate adjacent through lanes or adjacent mandatory turn lanes from each other. The length of the solid white lane line markings should be as depicted in Figure 3B-11.

26A *(DE Revision)* On approaches to bypass lanes, a solid white lane line marking should be used to separate the through lane from the bypass lane as depicted in Figure 3B-11A.

## Option:

27 Where the median width allows the left-turn lanes to be separated from the through lanes to give drivers on opposing approaches a less obstructed view of opposing through traffic, white pavement markings may be used to form channelizing islands as shown in Figure 2B-17.

28 Solid white lane line markings may be used to separate through traffic lanes from auxiliary lanes, such as an added uphill truck lane or a preferential lane (see Section 3D.02).

29 Wide solid lane line markings may be used for greater emphasis.

**Standard:**

30 **Where crossing the lane line markings is prohibited, the lane line markings shall consist of a solid double white line (see Figure 3B-12).**

**Section 3B.05 Other White Longitudinal Pavement Markings****Standard:**

01 **A channelizing line shall be a wide or double solid white line.**

*Guidance:*

01A *(DE Revision)* Channelizing lines along all state-maintained roadways should be 10 inches wide.

## Option:

02 Channelizing lines may be used to form channelizing islands where traffic traveling in the same direction is permitted on both sides of the island.

**Standard:**

03 **Other pavement markings in the channelizing island area shall be white.**

## Support:

04 *(DE Revision)* Examples of channelizing line applications are shown in Figures 3B-8, 3B-8A, 3B-9, 3B-9A, 3B-10, 3B-10A, and in Drawing C of Figure 3B-15.

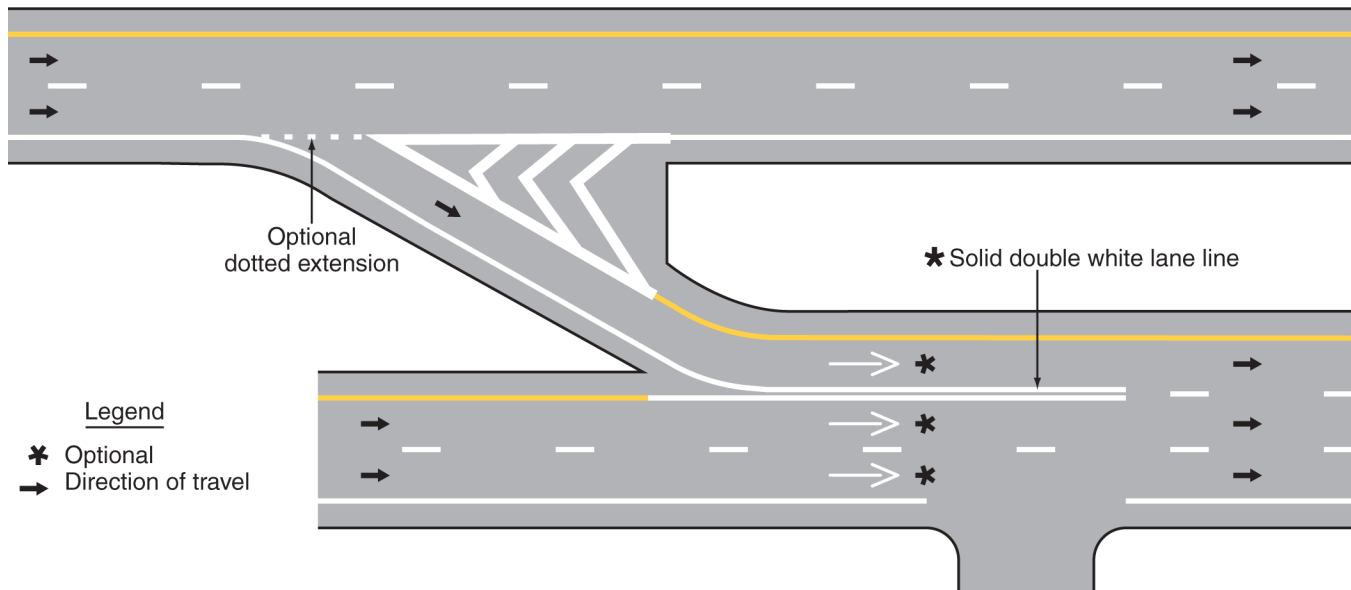
05 *(DE Revision)* Channelizing lines at exit ramps as shown in Figures 3B-8, 3B-8A, 3B-10, and 3B-10A define the neutral area, direct exiting traffic at the proper angle for smooth divergence from the main lanes into the ramp, and reduce the probability of colliding with objects adjacent to the roadway.

06 *(DE Revision)* Channelizing lines at entrance ramps as shown in Figures 3B-9, 3B-9A, 3B-10, and 3B-10A promote orderly and efficient merging with the through traffic.

**Standard:**

07 *(DE Revision)* **For all exit ramps and for entrance ramps with parallel acceleration lanes, channelizing lines shall be placed on both sides of the neutral area (see Figures 3B-8 and 3B-8A, 3B-10, 3B-10A, and Drawing A of Figures 3B-9 and 3B-9A).**

08 *(DE Revision)* **For entrance ramps with tapered acceleration lanes, channelizing lines shall be placed along both sides of the neutral area to a point at least one-half of the distance to the theoretical gore.**

**Figure 3B-12. Example of Solid Double White Lines Used to Prohibit Lane Changing****Guidance:**

09 (DE Revision) For entrance ramps with tapered acceleration lanes, the channelizing lines *should* extend to the theoretical gore as shown in Drawing B of Figures 3B-9 and 3B-9A.

09A (DE Revision) White chevron crosshatch markings (see Section 3B.24) *should* be placed in the neutral area of exit ramp gores for special emphasis as shown in Figures 3B-8, 3B-8A, 3B-10, and 3B-10A.

**Option:**

10 (DE Revision) White chevron crosshatch markings (see Section 3B.24) may be placed in the neutral area of entrance ramp gores for special emphasis. The channelizing lines and the optional chevron crosshatch markings at exit ramp and entrance ramp gores may be supplemented with white retroreflective or internally illuminated raised pavement markers (see Sections 3B.11 and 3B.13) for enhanced nighttime visibility.

**Section 3B.06 Edge Line Pavement Markings****Standard:**

01 **If used, edge line pavement markings shall delineate the right or left edges of a roadway.**

02 **Except for dotted edge line extensions (see Section 3B.08), edge line markings shall not be continued through intersections or major driveways.**

03 **If used on the roadways of divided highways or one-way streets, or on any ramp in the direction of travel, left edge line pavement markings shall consist of a normal solid yellow line to delineate the left-hand edge of a roadway or to indicate driving or passing restrictions left of these markings.**

04 **If used, right edge line pavement markings shall consist of a normal solid white line to delineate the right-hand edge of the roadway.**

**Guidance:**

05 *Edge line markings should not be broken for minor driveways.*

**Support:**

05A (DE Revision) DelDOT's Design Guidance Memorandum No. 1-16 defines high volume driveways as having an ADT greater than 400 vehicles per day.

06 Edge line markings have unique value as visual references to guide road users during adverse weather and visibility conditions.

**Option:**

07 Wide solid edge line markings may be used for greater emphasis.

### Section 3B.07 Warrants for Use of Edge Lines

#### Standard:

01 **(DE Revision)** Edge line markings shall be placed on paved **and surface-treated roadways** with the following characteristics:

- A. **Interstates,**
- B. **Freeways,**
- C. **Expressways, and**
- D. **Roads with a traveled way of 20 feet or more in width and an ADT of 3,000 vehicles per day or greater.**

#### Guidance:

02 *(DE Revision)* Edge line markings should be placed on paved *and surface-treated roadways* where an engineering study indicates a need for edge line markings.

03 *Edge line markings should not be placed where an engineering study or engineering judgment indicates that providing them is likely to decrease safety.*

#### Option:

04 Edge line markings may be placed on streets and highways with or without center line markings.

05 Edge line markings may be excluded, based on engineering judgment, for reasons such as if the traveled way edges are delineated by curbs, parking, or other markings.

06 If a bicycle lane is marked on the outside portion of the traveled way, the edge line that would mark the outside edge of the bicycle lane may be omitted.

07 Edge line markings may be used where edge delineation is desirable to minimize unnecessary driving on paved shoulders or on refuge areas that have lesser structural pavement strength than the adjacent roadway.

### Section 3B.08 Extensions Through Intersections or Interchanges

#### Standard:

01 **Except as provided in Paragraph 2, pavement markings extended into or continued through an intersection or interchange area shall be the same color and at least the same width as the line markings they extend (see Figure 3B-13).**

#### Option:

02 A normal line may be used to extend a wide line through an intersection.

#### Guidance:

03 *(DE Revision)* Where highway design or reduced visibility conditions make it desirable to provide control or to guide vehicles through an intersection or interchange, such as at offset, skewed, complex, or multi-legged intersections, on curved roadways, where multiple turn lanes are used, or where offset left turn lanes might cause driver confusion, dotted line extension markings consisting of 2-foot line segments and 6-foot gaps should be used to extend longitudinal line markings through an intersection or interchange area.

#### Option:

04 Dotted edge line extensions may be placed through intersections or major driveways.

#### Guidance:

05 *Where greater restriction is required, solid lane lines or channelizing lines should be extended into or continued through intersections or major driveways.*

#### Standard:

06 **Solid lines shall not be used to extend edge lines into or through intersections or major driveways.**

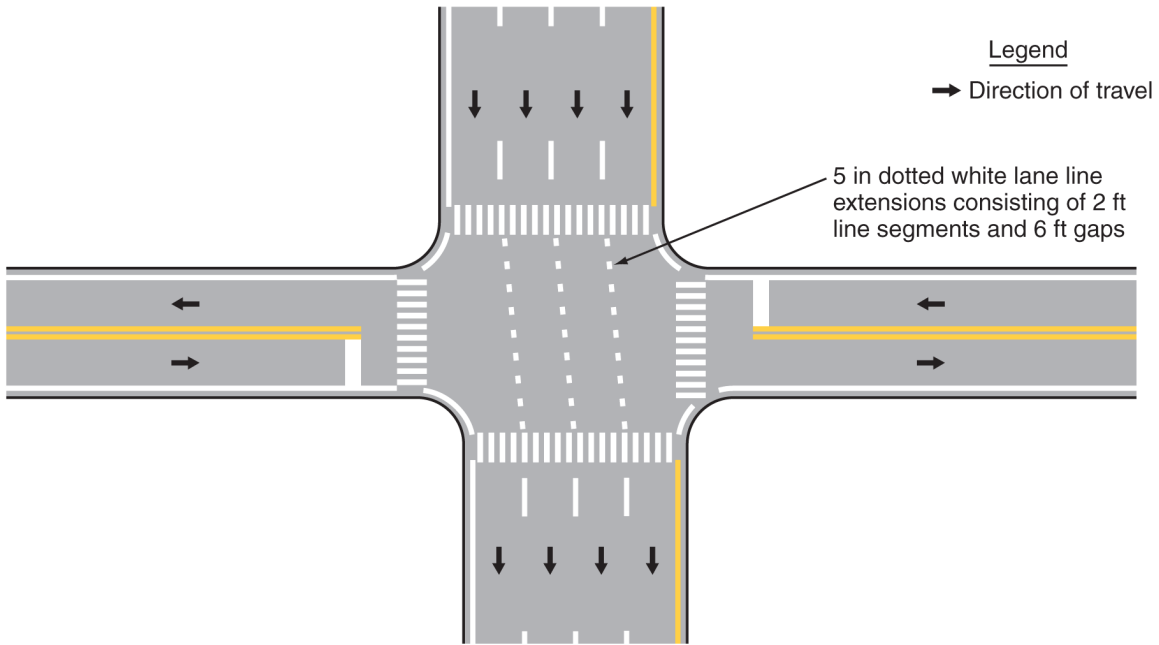
#### Guidance:

07 *Where a double line is extended through an intersection, a single line of equal width to one of the lines of the double line should be used.*

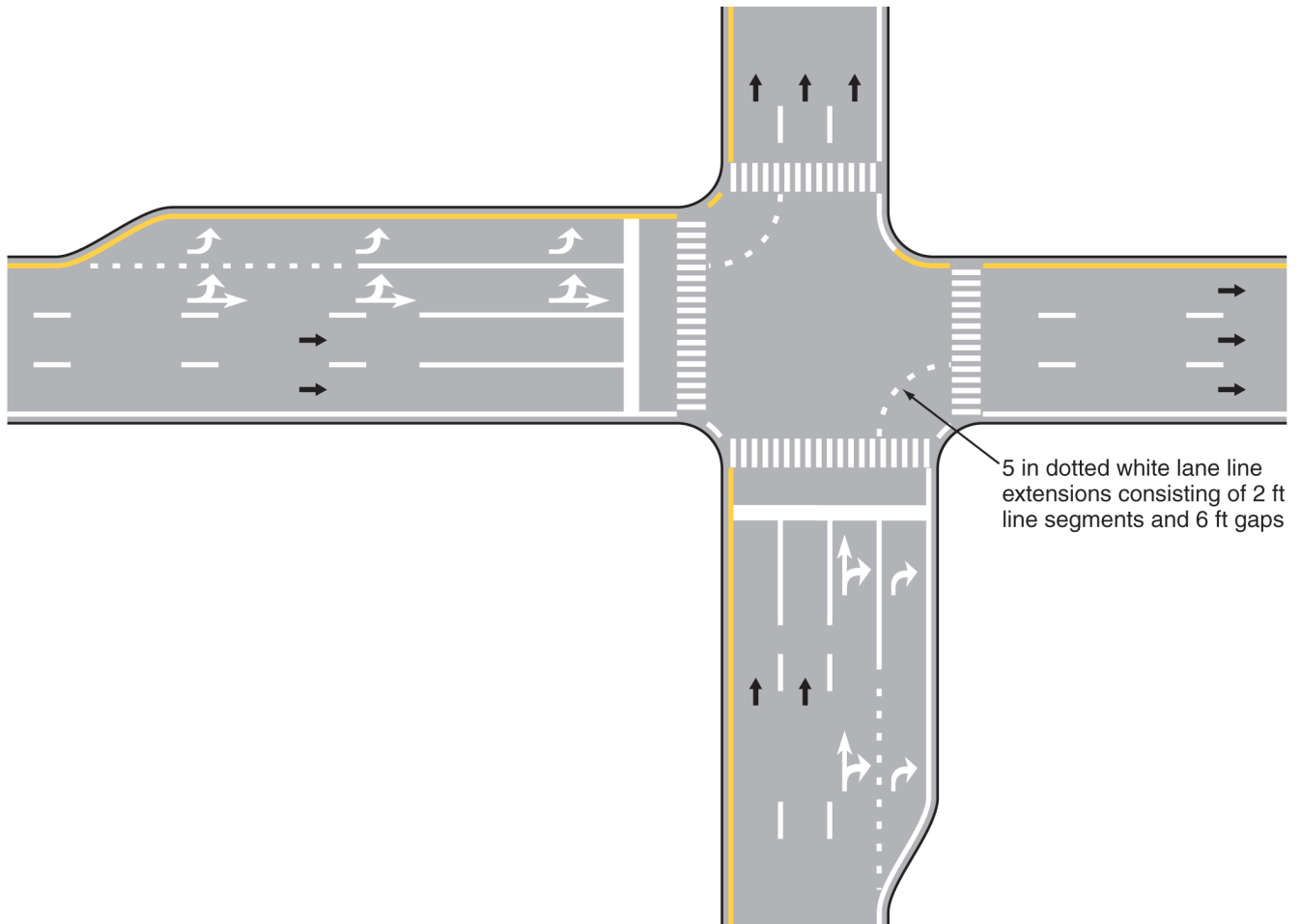
08 *To the extent possible, pavement marking extensions through intersections should be designed in a manner that minimizes potential confusion for drivers in adjacent or opposing lanes.*

**Figure 3B-13. Examples of Line Extensions through Intersections (Sheet 1 of 2)**  
**(Delaware Revision)**

**A - Typical pavement markings with offset lane lines continued through the intersection and crosswalk lines and stop lines**

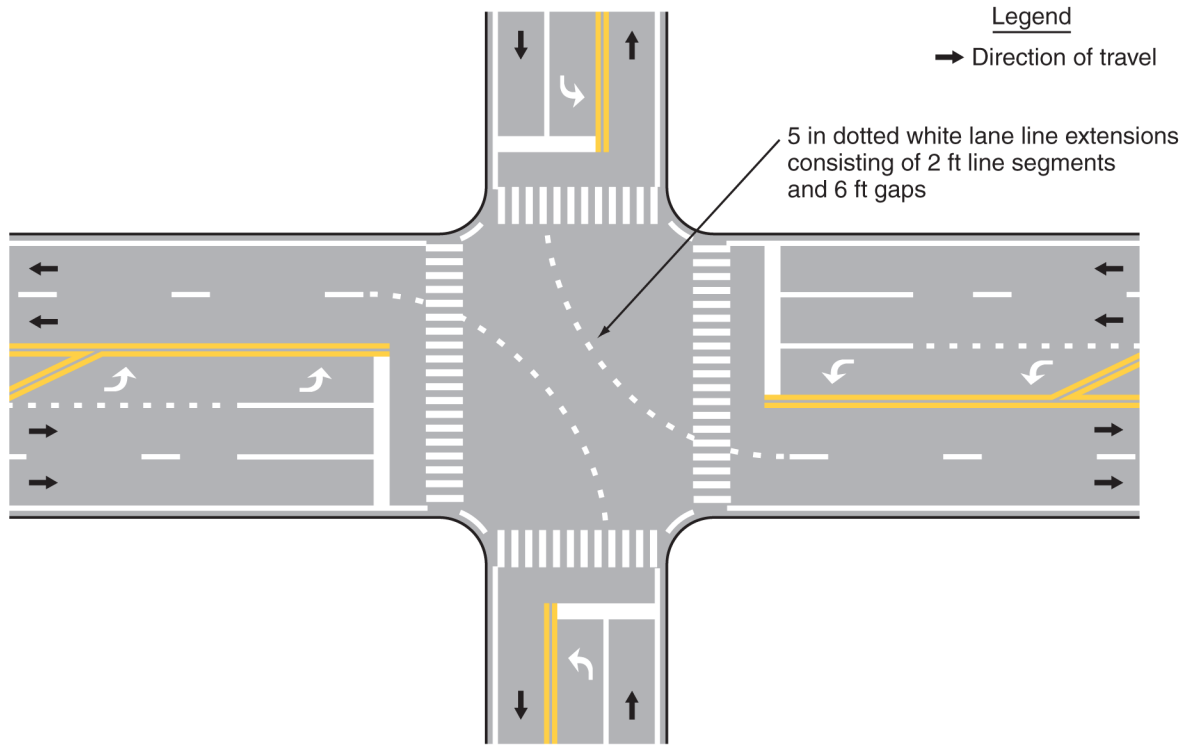


**B - Typical pavement markings with double-turn lanes, lane-use turn arrows, and crosswalk lines, stop lines, and line extensions into intersection for double turns**

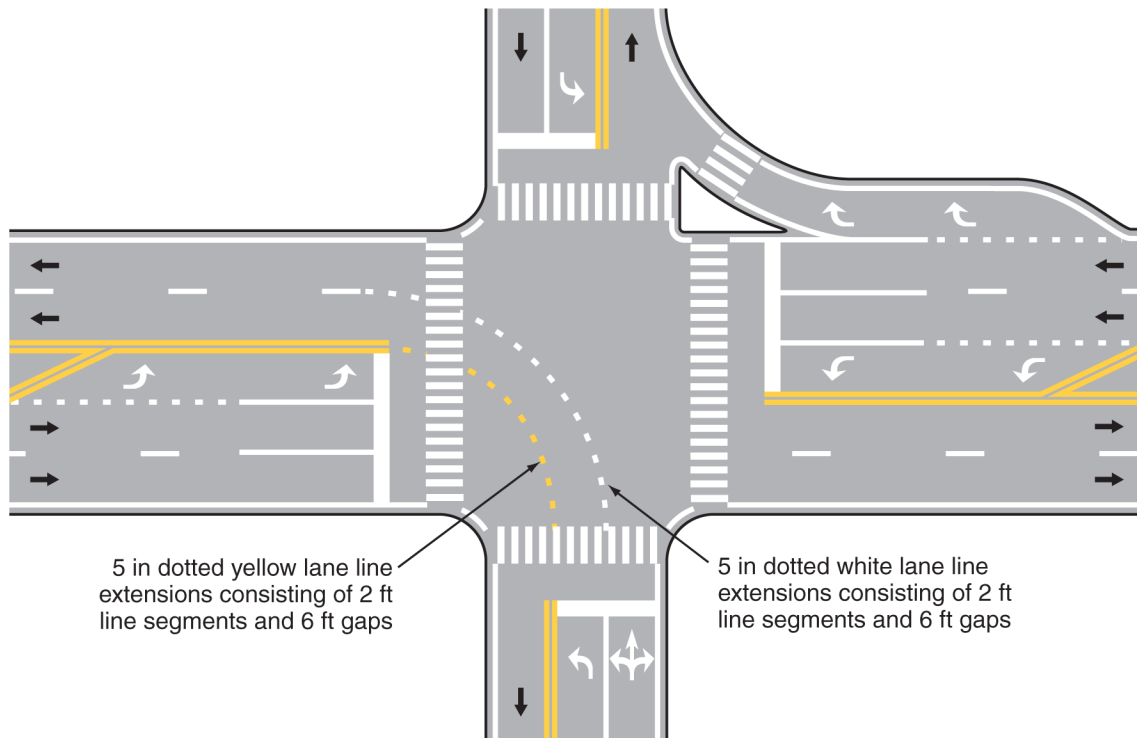


**Figure 3B-13. Examples of Line Extensions through Intersections (Sheet 2 of 2)  
(Delaware Revision)**

**C - Typical dotted line markings to extend lane line markings into the intersection**



**D - Typical dotted line markings to extend center line and lane line markings into the intersection**



### Section 3B.09 Lane-Reduction Transition Markings

#### Support:

01 Lane-reduction transition markings are used where the number of through lanes is reduced because of narrowing of the roadway or because of a section of on-street parking in what would otherwise be a through lane. Lane-reduction transition markings are not used for lane drops.

#### Standard:

02 **Except as provided in Paragraph 3, where pavement markings are used, lane-reduction transition markings shall be used to guide traffic through transition areas where the number of through lanes is reduced, as shown in Figure 3B-14. On two-way roadways, no-passing zone markings shall be used to prohibit passing in the direction of the convergence, and shall continue through the transition area.**

#### Option:

03 On low-speed urban roadways where curbs clearly define the roadway edge in the lane-reduction transition, or where a through lane becomes a parking lane, the edge line and/or delineators shown in Figure 3B-14 may be omitted as determined by engineering judgment.

#### Guidance:

04 *For roadways having a posted or statutory speed limit of 45 mph or greater, the transition taper length for a lane-reduction transition should be computed by the formula  $L = WS$ . For roadways where the posted or statutory speed limit is less than 45 mph, the formula  $L = WS^2/60$  should be used to compute the taper length.*

04A *(DE Revision) Lane-reduction transition markings along interstates, freeways, and expressways should be installed as shown in Figure 3B-14A. Lane-reduction transition markings beyond intersections should be installed as shown in Figures 3B-14B and 3B-14C.*

#### Option:

04B *(DE Revision) Lane-reduction markings shown in Figures 3B-14A, 3B-14B, and 3B-14C may be adjusted based on engineering judgment at existing locations where space is limited due to site-specific conditions.*

#### Support:

05 Under both formulas, L equals the taper length in feet, W equals the width of the offset distance in feet, and S equals the 85<sup>th</sup>-percentile speed or the posted or statutory speed limit, whichever is higher.

#### Guidance:

06 *Where observed speeds exceed posted or statutory speed limits, longer tapers should be used.*

#### Option:

07 On new construction, where no posted or statutory speed limit has been established, the design speed may be used in the transition taper length formula.

#### Guidance:

08 *(DE Revision) Lane line markings should be discontinued where the transition taper begins.*

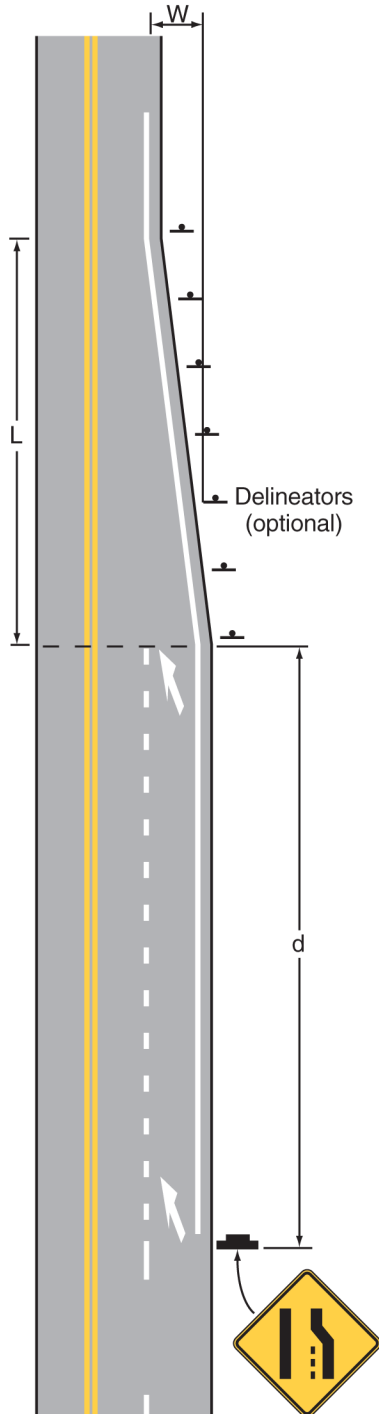
09 *Except as provided in Paragraph 3 for low-speed urban roadways, the edge line markings shown in Figure 3B-14 should be installed from the location of the Lane Ends warning sign to beyond the beginning of the narrower roadway.*

#### Support:

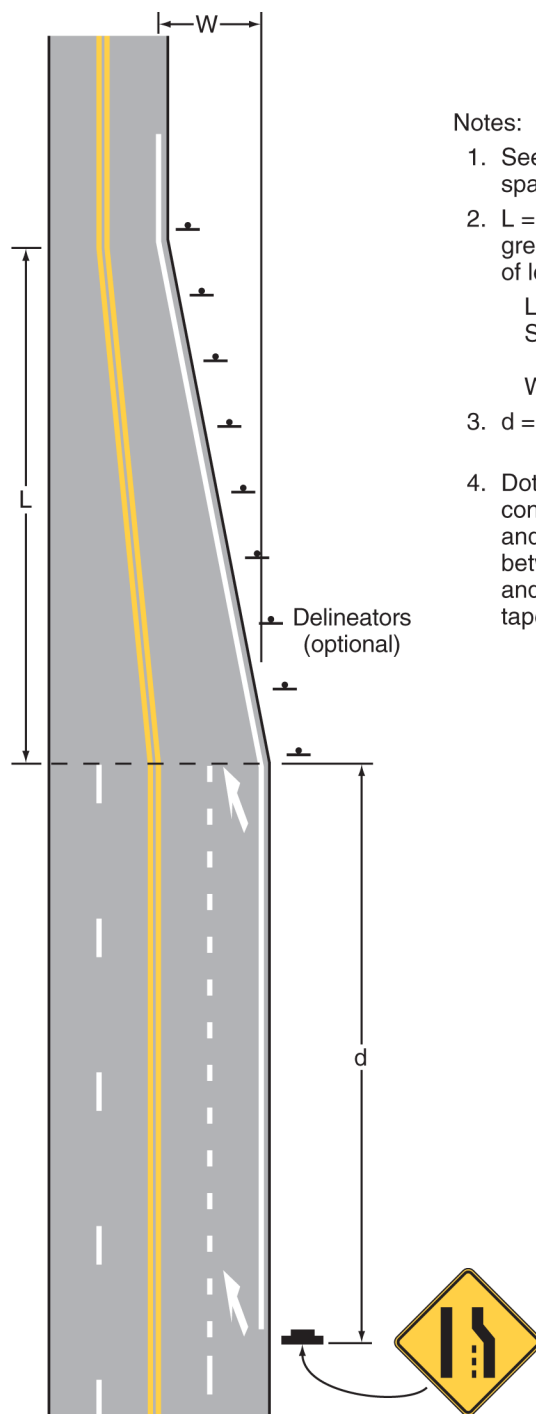
10 Pavement markings at lane-reduction transitions supplement the standard signs. See Section 3B.20 for provisions regarding use of lane-reduction arrows.

**Figure 3B-14. Examples of Applications of Lane-Reduction Transition Markings  
(Delaware Revision)**

**A – Lane reduction**



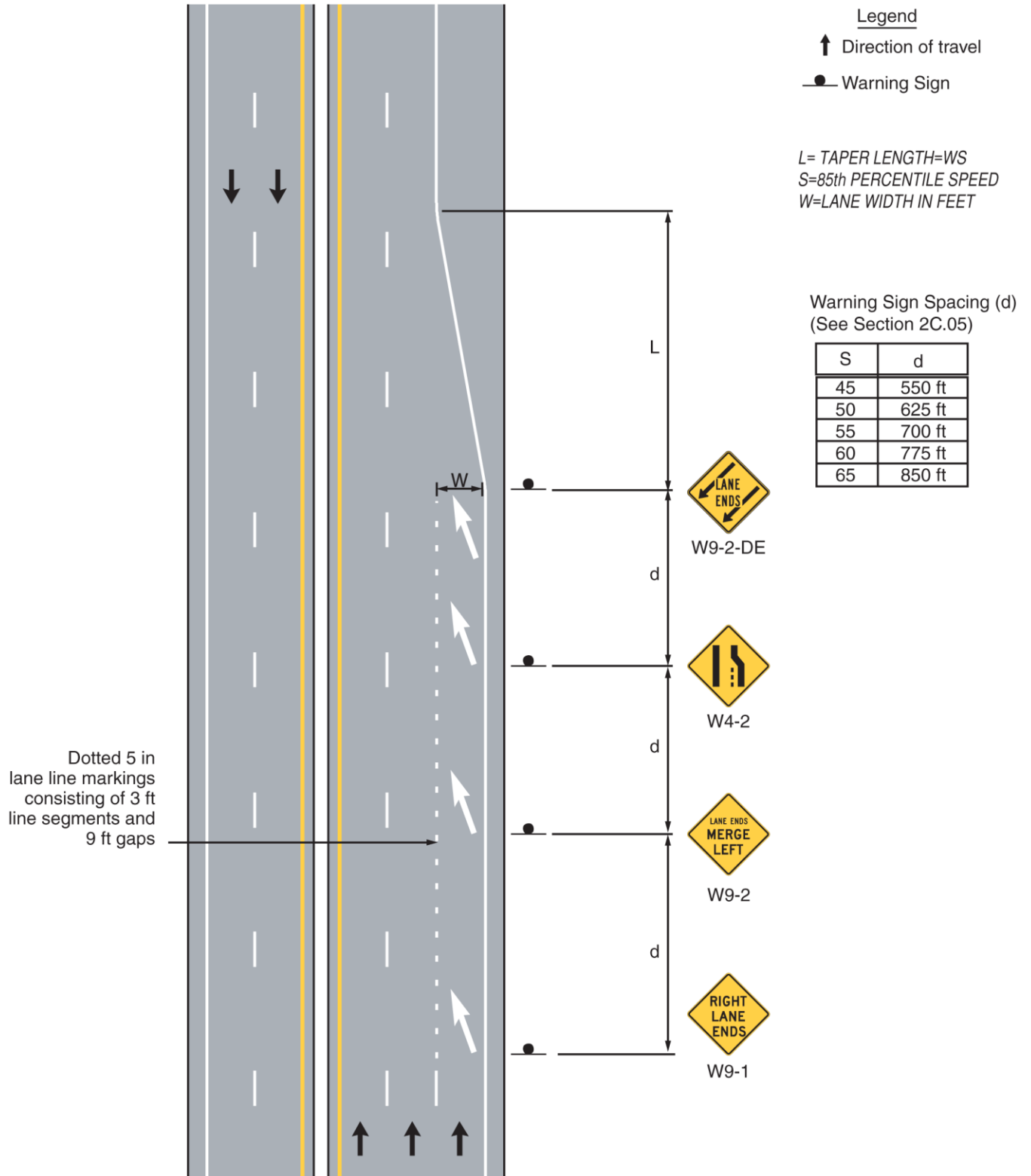
**B – Lane reduction with lateral shift to the left**



Notes:

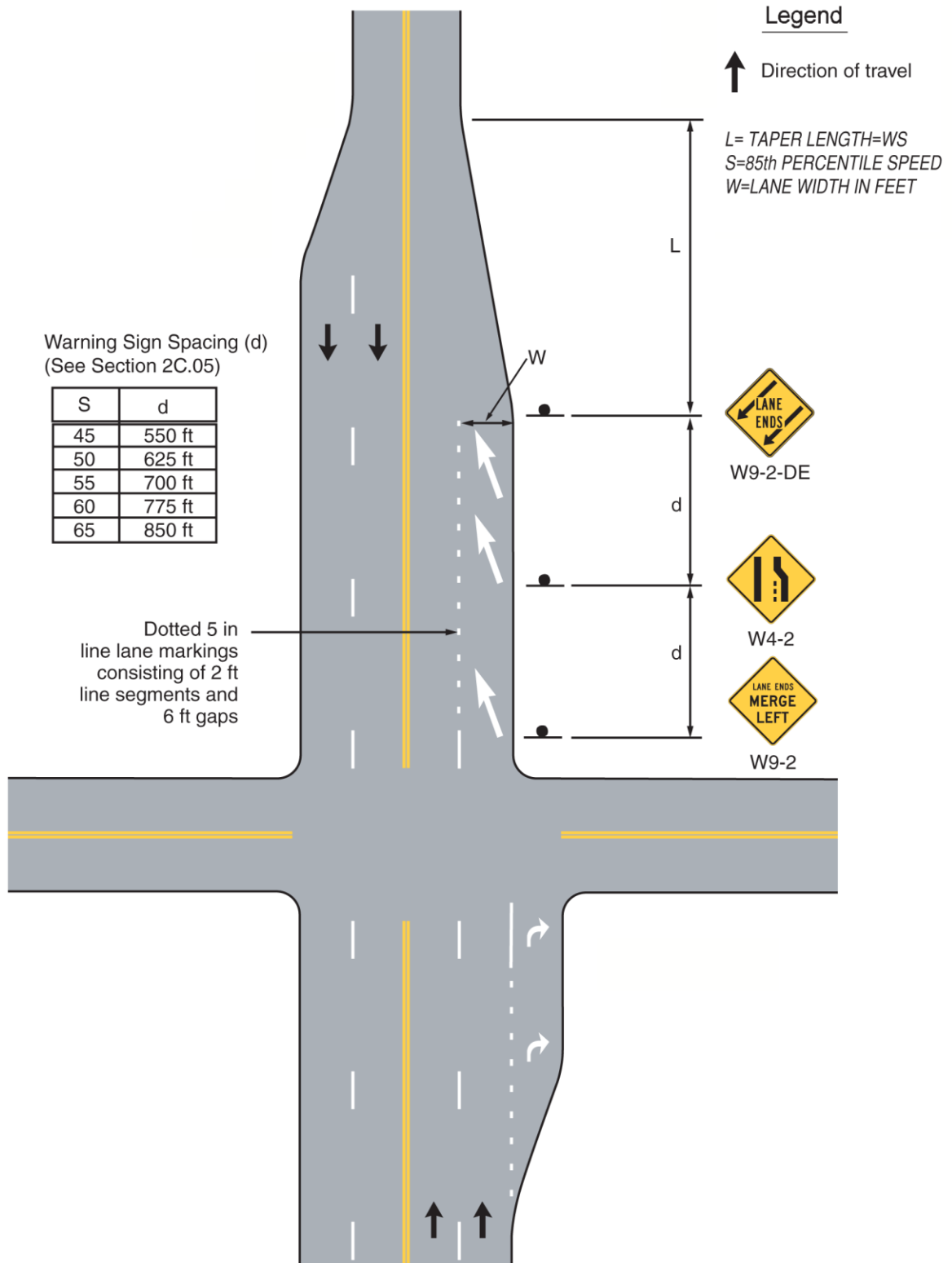
1. See Section 3F.04 for delineator spacing
2.  $L = WS$  for speeds of 45 mph or greater and  $L = WS^2/60$  for speeds of less than 45 mph, where:  
 $L$  = Length of taper in feet  
 $S$  = Posted, 85th-percentile, or statutory speed in mph  
 $W$  = Offset in feet
3.  $d$  = Advance warning distance (see Section 2C.05)
4. Dotted 5 in lane line markings consisting of 2 ft line segments and 6 ft gaps should be installed between the first Lane Ends sign and the beginning of the transition taper

**Figure 3B-14A. Example of Lane Reduction Markings for Interstates, Freeways or Expressways (45 MPH or greater)  
(Delaware Revision)**

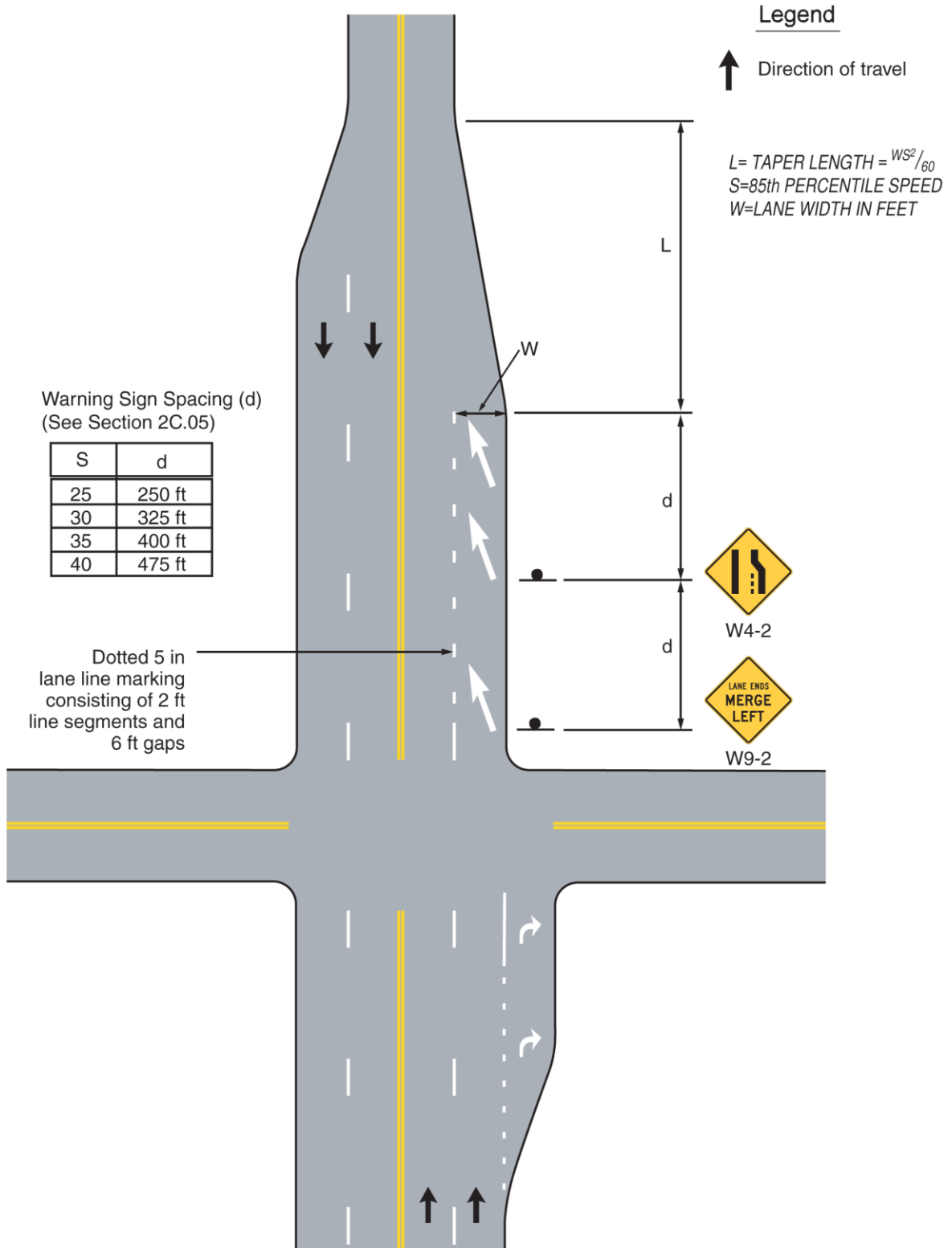




**Figure 3B-14B. Example of Lane Reduction Beyond Intersection Marking Application along All Other Roads (Non-Interstates, Freeways or Expressways) (45 MPH or greater) (Delaware Revision)**



**Figure 3B-14C. Example of Lane Reduction Beyond Intersection Marking Application along All Other Roads (Non-Interstates, Freeways or Expressways) (less than 45 MPH) (Delaware Revision)**



## Section 3B.10 Approach Markings for Obstructions

### Standard:

01 **Pavement markings shall be used to guide traffic away from fixed obstructions within a paved roadway. Approach markings for bridge supports, refuge islands, median islands, toll plaza islands, and raised channelization islands shall consist of a tapered line or lines extending from the center line or the lane line to a point 1 to 2 feet to the right-hand side, or to both sides, of the approach end of the obstruction (see Figure 3B-15).**

### Support:

02 See Chapter 3E for additional information on approach markings for toll plaza islands.

### Guidance:

03 *For roadways having a posted or statutory speed limit of 45 mph or greater, the taper length of the tapered line markings should be computed by the formula  $L = WS$ . For roadways where the posted or statutory speed limit is less than 45 mph, the formula  $L = WS^2/60$  should be used to compute the taper length.*

### Support:

04 Under both formulas, L equals the taper length in feet, W equals the width of the offset distance in feet, and S equals the 85<sup>th</sup>-percentile speed or the posted or statutory speed limit, whichever is higher.

### Guidance:

05 *The minimum taper length should be 100 feet in urban areas and 200 feet in rural areas.*

### Support:

06 Examples of approach markings for obstructions in the roadway are shown in Figure 3B-15.

### Standard:

07 **If traffic is required to pass only to the right of the obstruction, the markings shall consist of a two-direction no-passing zone marking at least twice the length of the diagonal portion as determined by the appropriate taper formula (see Drawing A of Figure 3B-15).**

### Option:

08 If traffic is required to pass only to the right of the obstruction, yellow diagonal crosshatch markings (see Section 3B.24) may be placed in the flush median area between the no-passing zone markings as shown in Drawings A and B of Figure 3B-15. Other markings, such as yellow delineators, yellow channelizing devices, yellow raised pavement markers, and white crosswalk pavement markings, may also be placed in the flush median area.

### Standard:

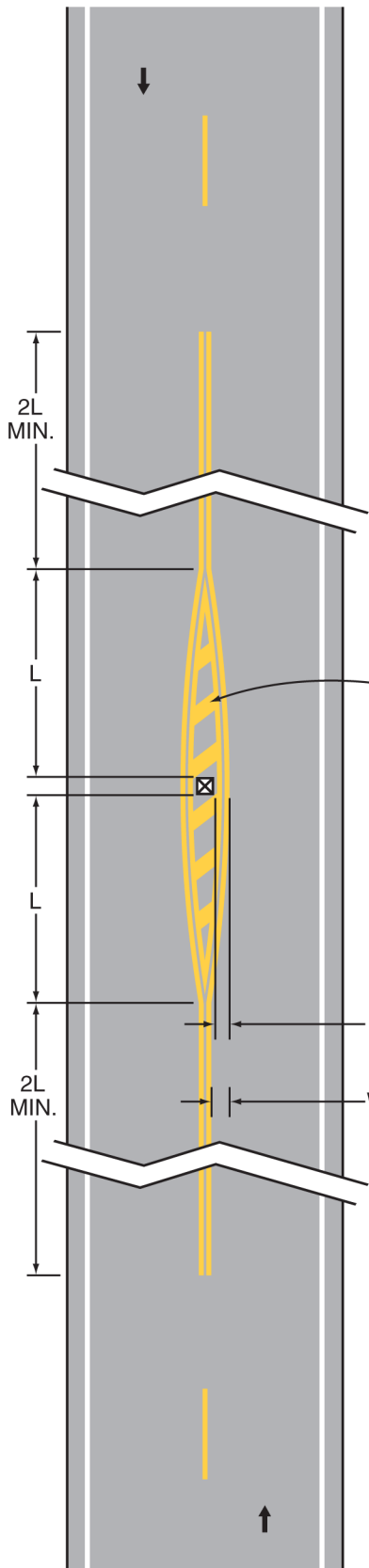
09 **If traffic can pass either to the right or left of the obstruction, the markings shall consist of two channelizing lines diverging from the lane line, one to each side of the obstruction. In advance of the point of divergence, a wide solid white line or normal solid double white line shall be extended in place of the broken lane line for a distance equal to the length of the diverging lines (see Drawing C of Figure 3B-15).**

### Option:

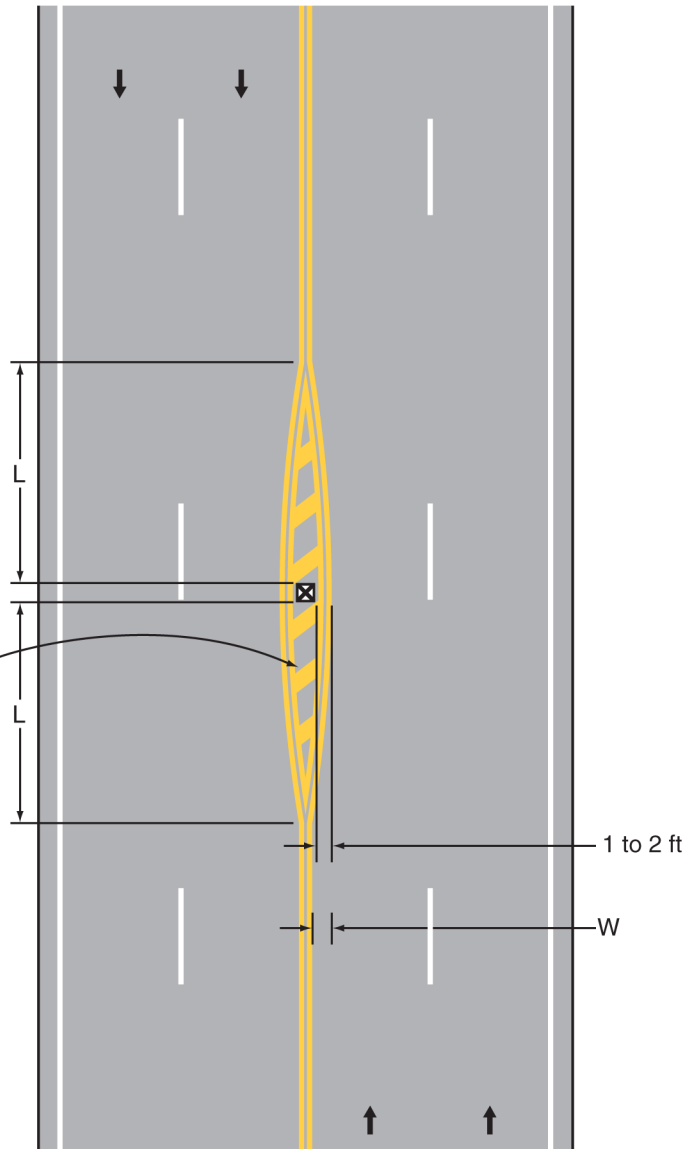
10 If traffic can pass either to the right or left of the obstruction, additional white chevron crosshatch markings (see Section 3B.24) may be placed in the flush median area between the channelizing lines as shown in Drawing C of Figure 3B-15. Other markings, such as white delineators, white channelizing devices, white raised pavement markers, and white crosswalk markings may also be placed in the flush median area.

**Figure 3B-15. Examples of Applications of Markings for Obstructions in the Roadway**  
 (Sheet 1 of 2)  
**(Delaware Revision)**

**A - Center of a two-lane road**



**B - Center of a four-lane road**



12 in crosshatch markings typically spaced at 25 ft intervals and angled 45 degrees

- Legend**
- ➔ Direction of travel
  - ⊠ Obstruction

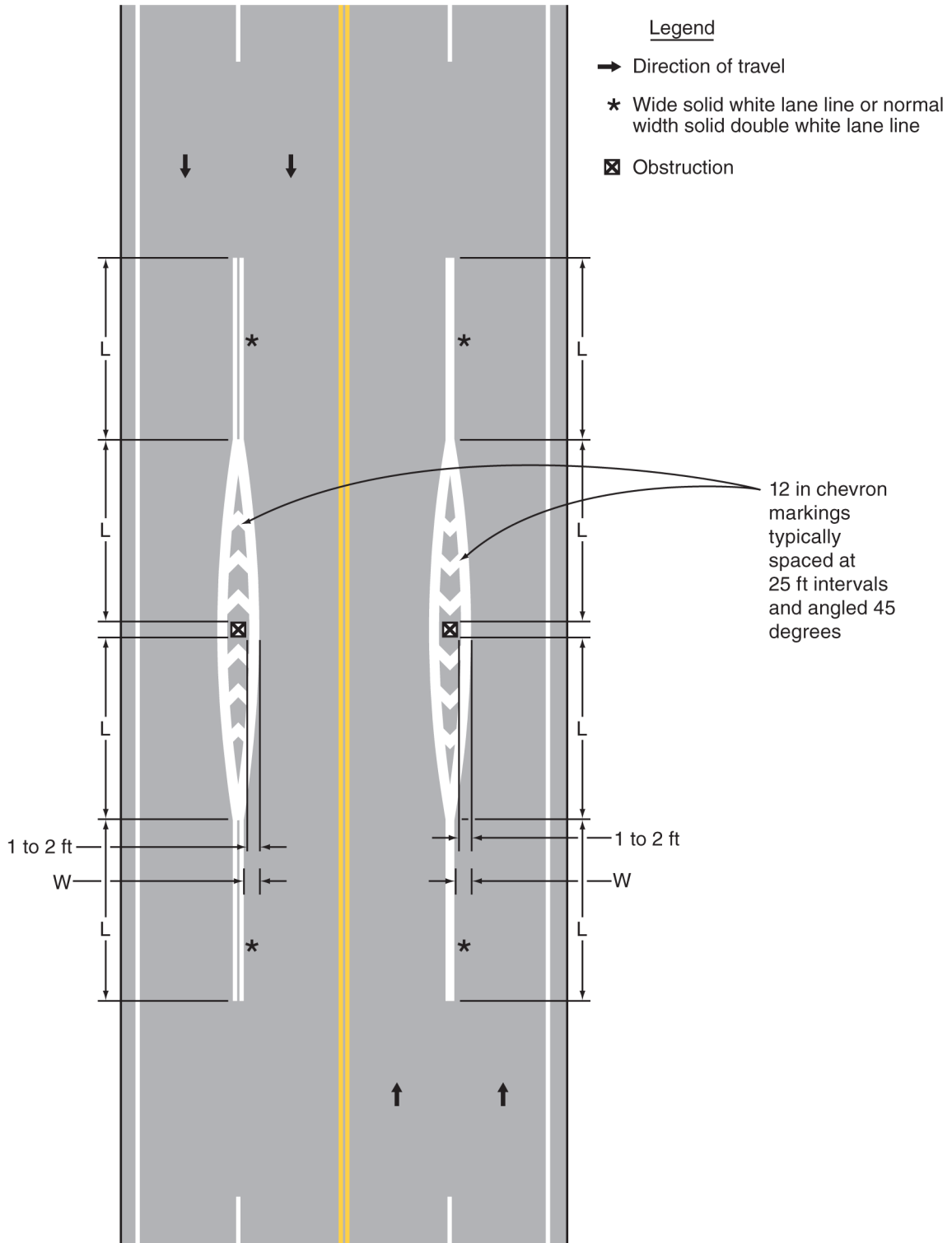
For speeds 45 mph or more:  $L = WS$   
 For speeds less than 45 mph:  $L = WS^2/60$   
 S = Posted, 85th-percentile, or statutory speed in mph  
 W = Offset distance in feet

Minimum length of : L = 100 feet in urban areas  
 L = 200 feet in rural areas

Length "L" should be extended as required by sight distance conditions

**Figure 3B-15. Examples of Applications of Markings for Obstructions in the Roadway**  
 (Sheet 2 of 2)  
**(Delaware Revision)**

**C - Traffic passing in the same direction on both sides of an obstruction**



For speeds of 45 mph or more:  $L = WS$   
 For speeds of less than 45 mph:  $L = WS^2/60$   
 S = Posted, 85th-percentile, or statutory speed in mph  
 W = Offset distance in feet

Minimum length of: L = 100 feet in urban areas  
 L = 200 feet in rural areas

Length "L" should be extended as required by sight distance conditions

### Section 3B.11 Raised Pavement Markers – General

#### Standard:

01 **The color of raised pavement markers under both daylight and nighttime conditions shall conform to the color of the marking for which they serve as a positioning guide, or for which they supplement or substitute.**

#### Guidance:

01A *(DE Revision) Raised pavement markers should be installed along interstates, freeways, expressways, and principal arterials.*

01B *(DE Revision) Raised pavement markers should be considered for use along conventional roads under the following conditions:*

- A. *Roadways with posted speed limits of 45 miles per hour or greater, with horizontal and/or vertical curves, and areas of low lighting*
- B. *Locations with a history of roadway departure crashes*
- C. *Locations with advisory speed postings*
- D. *Locations where a barrier or parapet is less than 6 feet from the edge of the travel lane*

01C *(DE Revision) Raised pavement markers should also be installed on other roadways where engineering judgment indicates such a need.*

01D *(DE Revision) Raised pavement markers should not be installed along surface-treated roadways.*

01E *(DE Revision) Other than to delineate ramps and gore areas, raised pavement markers should not be installed along left or right edge lines unless there is a history of roadway departure and/or nighttime, inclement weather-related crashes.*

01F *(DE Revision) If used, raised pavement markers should be installed in accordance with Figures 3B-15A through 3B-15H.*

#### Option:

02 The side of a raised pavement marker that is visible to traffic proceeding in the wrong direction may be red (see Section 3A.05).

03 Retroreflective or internally illuminated raised pavement markers may be used in the roadway immediately adjacent to curbed approach ends of raised medians and curbs of islands, or on top of such curbs (see Section 3B.23).

#### Support:

04 Retroreflective and internally illuminated raised pavement markers are available in mono-directional and bidirectional configurations. The bidirectional marker is capable of displaying the applicable color for each direction of travel.

05 Blue raised pavement markers are sometimes used in the roadway to help emergency personnel locate fire hydrants.

#### Standard:

06 **When used, internally illuminated raised pavement markers shall be steadily illuminated and shall not be flashed.**

#### Support:

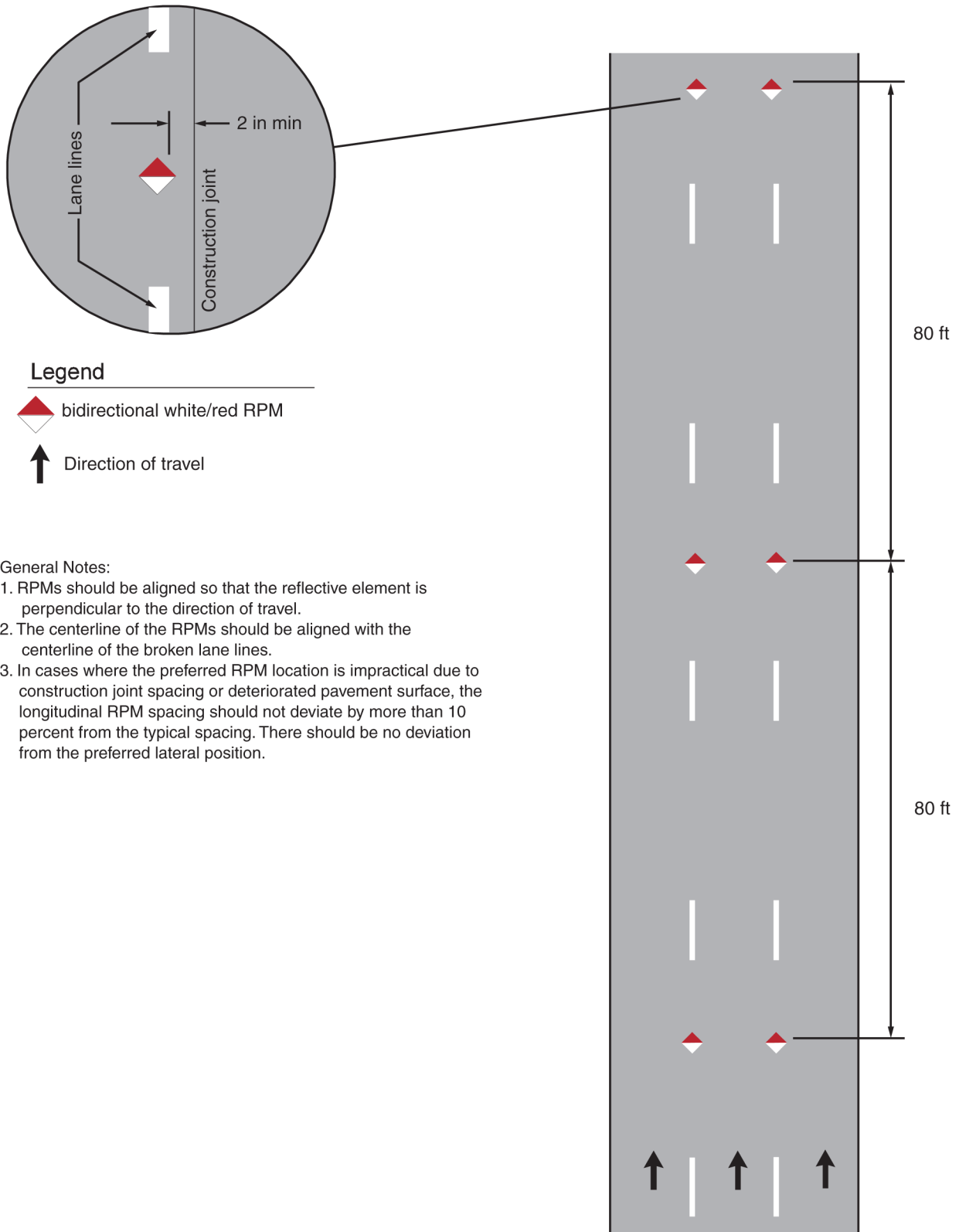
07 Flashing raised pavement markers are considered to be In-Roadway Lights (see Chapter 4N).

#### Guidance:

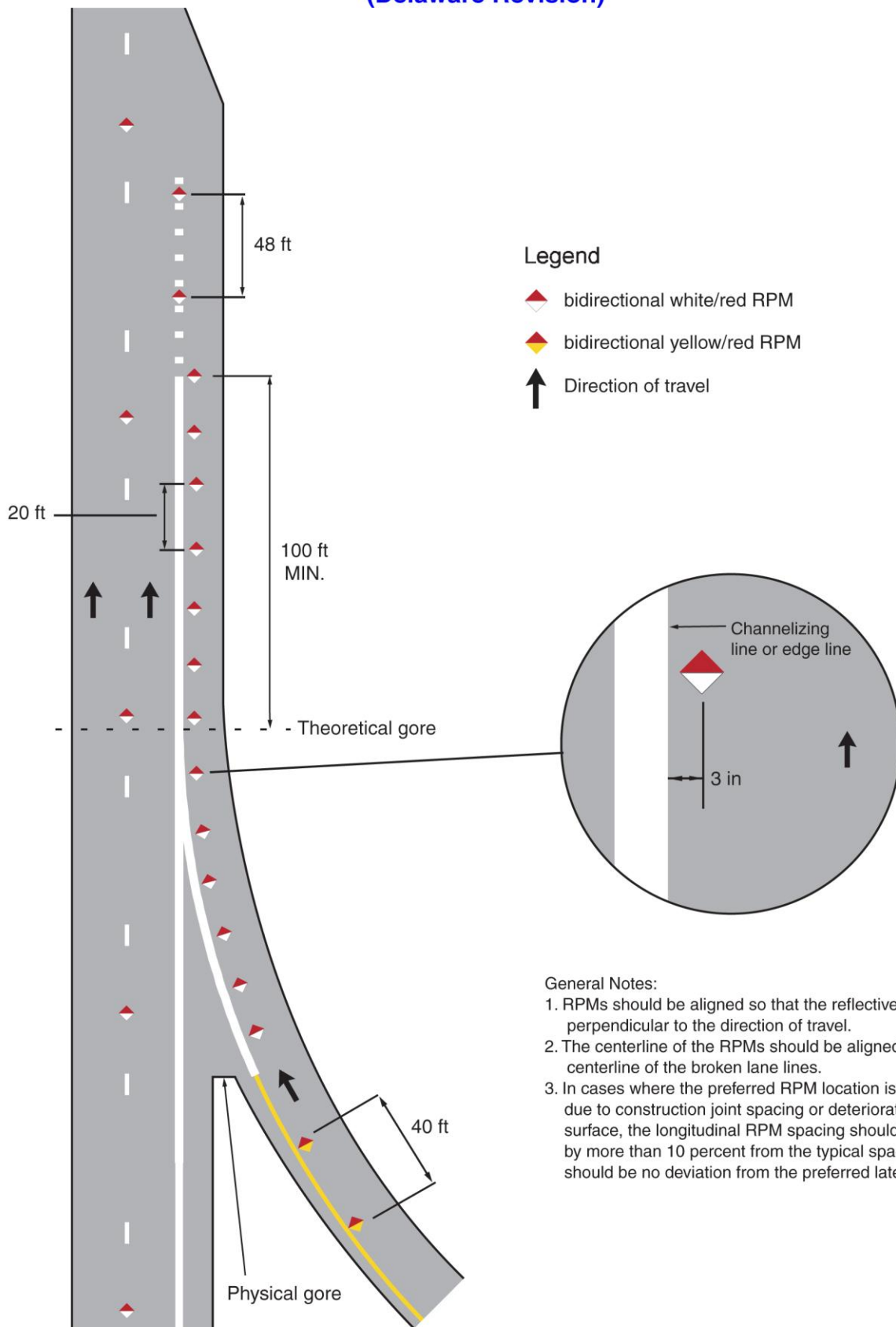
08 *Non-retroreflective raised pavement markers should not be used alone, without supplemental retroreflective or internally illuminated markers, as a substitute for other types of pavement markings.*

09 *Directional configurations should be used to maximize correct information and to minimize confusing information provided to the road user. Directional configurations also should be used to avoid confusion resulting from visibility of markers that do not apply to the road user.*

**Figure 3B-15A. Example of Raised Pavement Marker (RPM) Application  
(Delaware Revision)**

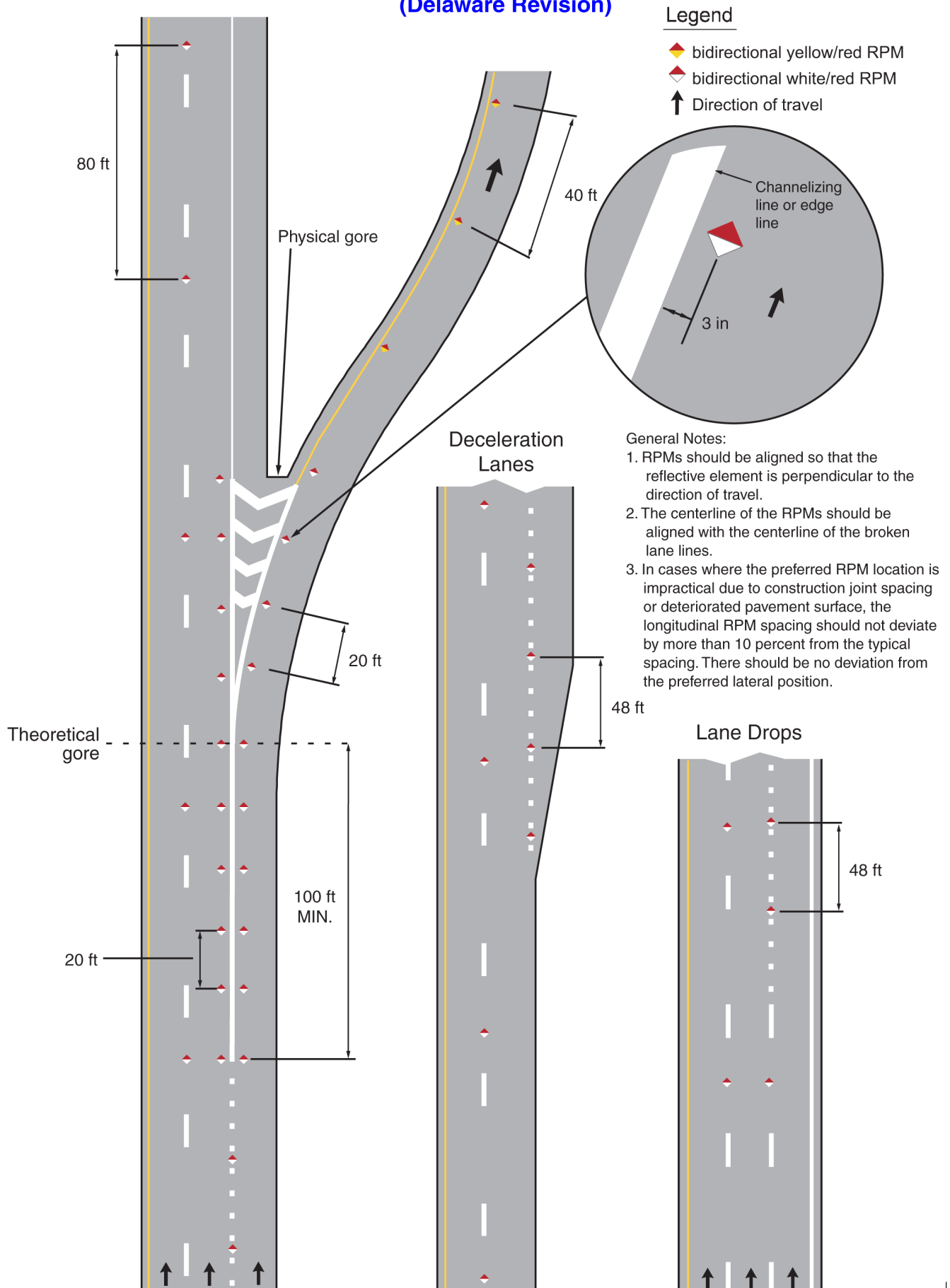


**Figure 3B-15B. Example of Raised Pavement Marker (RPM) Application on Entrance Ramps (Delaware Revision)**

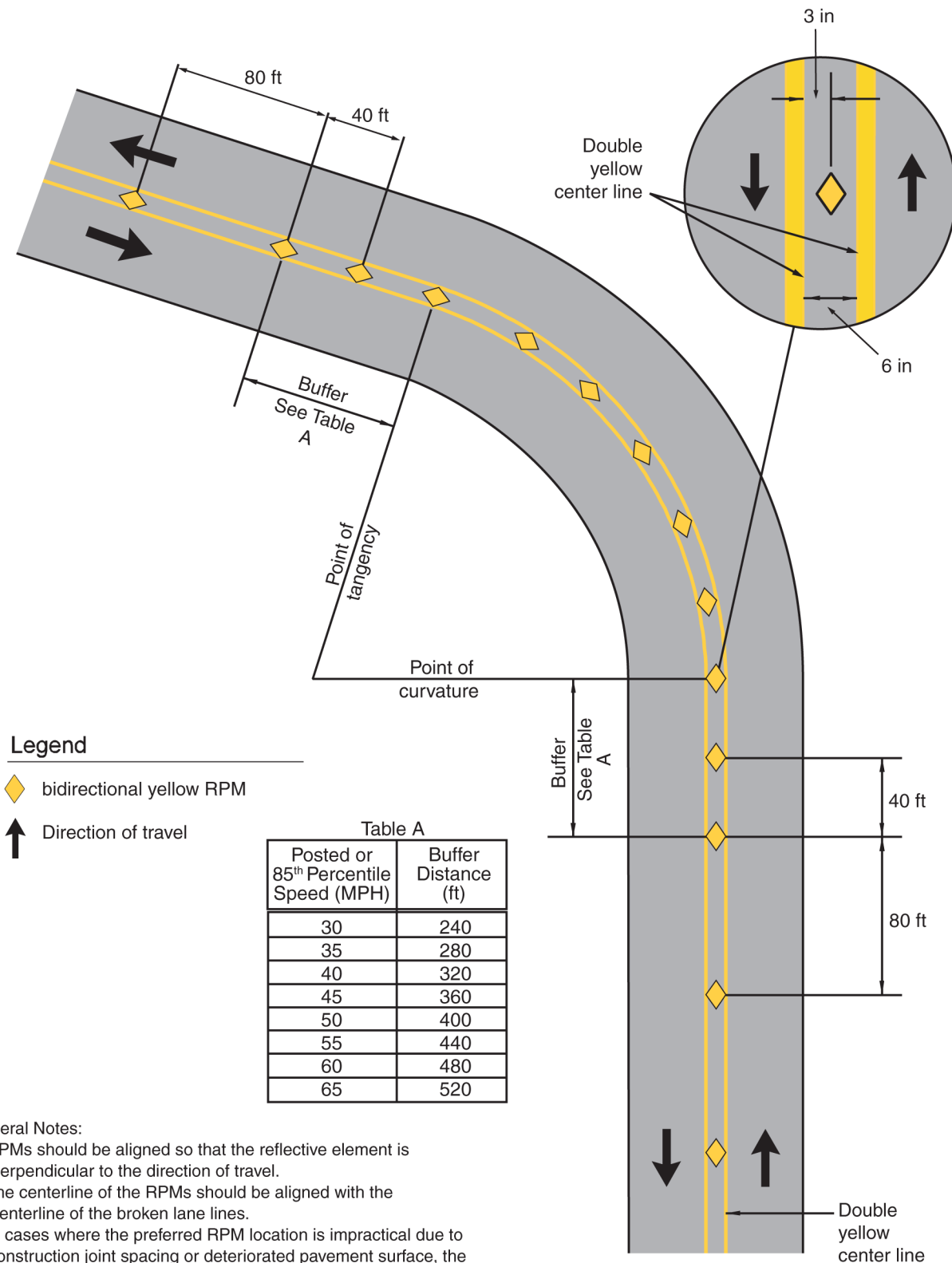




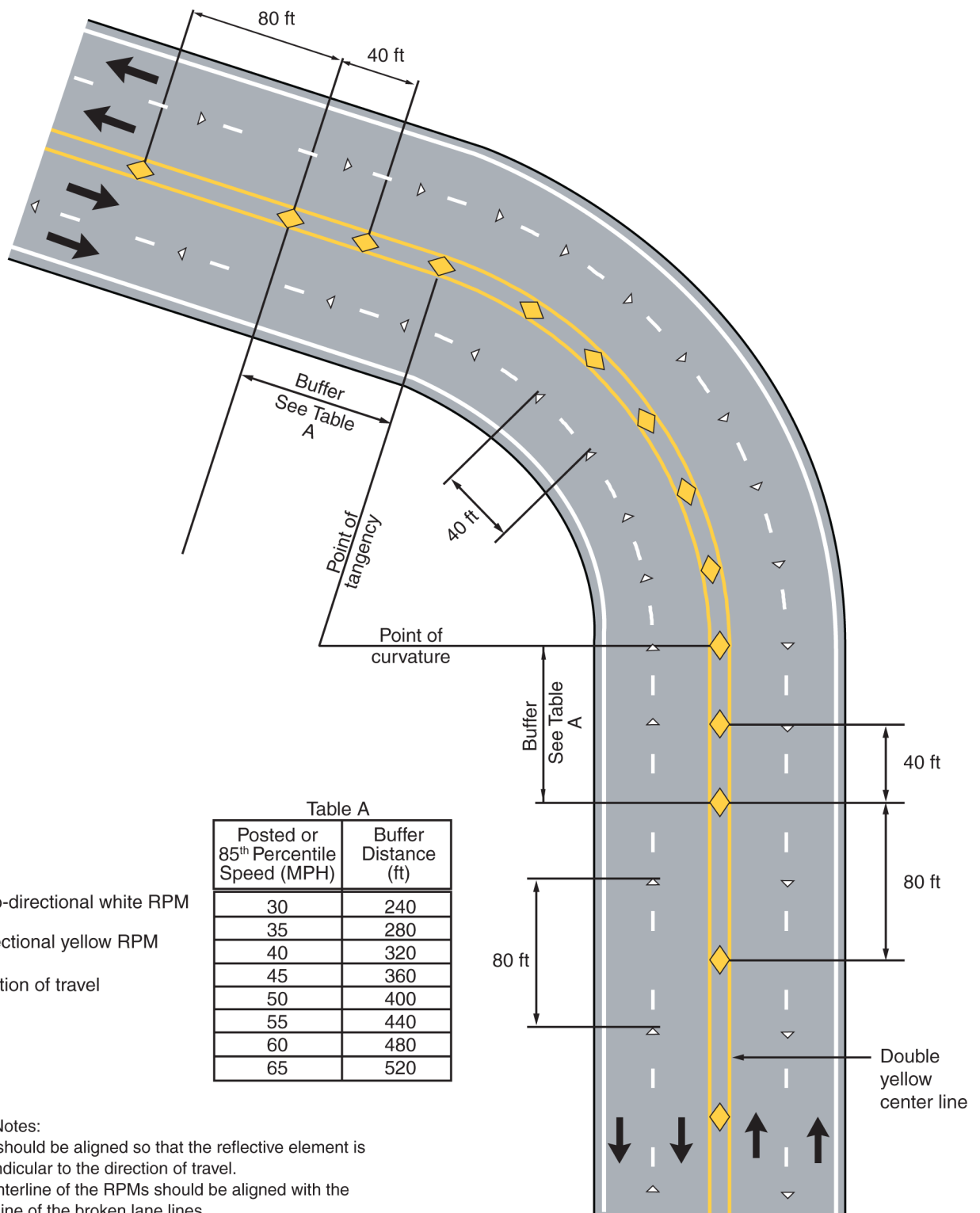
**Figure 3B-15C. Example of Raised Pavement Marker (RPM) Application on Exit Ramps (Delaware Revision)**



**Figure 3B-15D. Example of Raised Pavement Marker (RPM) Application at Curves along Two-Lane Roads (Delaware Revision)**



**Figure 3B-15E. Example of Raised Pavement Marker (RPM) Application at Curves along Multi-Lane Roads (Delaware Revision)**






### Figure 3B-15F. Example of Raised Pavement Marker (RPM) Application for Left-Turn Lane (Delaware Revision)

**Notes:**

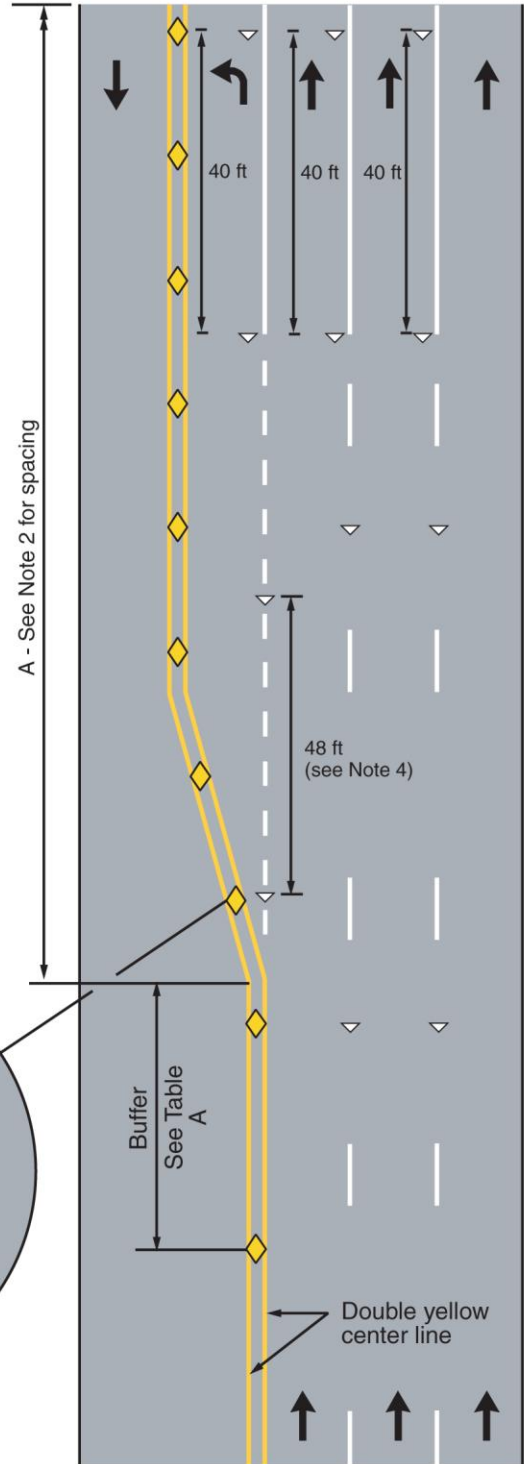
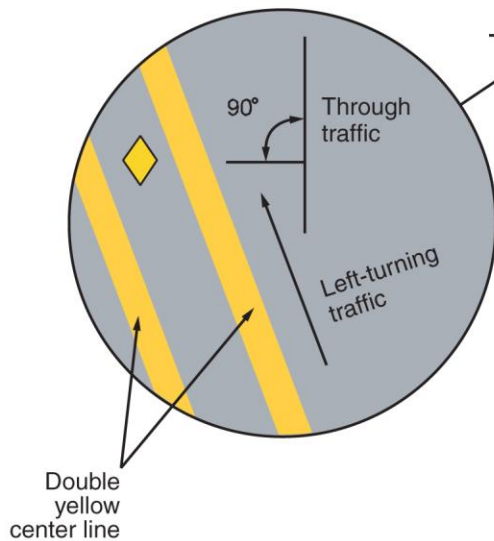
1. RPMs supplementing the double yellow center line should be installed between the two lines and oriented as shown in the detail below.
2. RPMs supplementing the double yellow center line along the length of the left-turn lane and taper should be spaced 20 ft apart if  $A < 200$  ft. If  $A \geq 200$  ft, RPMs should be spaced 40 ft apart along the length of the left-turn lane and taper, where A is the length of full-width left-turn lane and taper.
3. In cases where the preferred RPM location is impractical due to construction joint spacing or deteriorated pavement surface, the longitudinal RPM spacing should not deviate by more than 10 percent from the typical spacing. There should be no deviation from the preferred lateral position.
4. RPM spacing for all dotted lane lines should be 48 ft.
5. RPMs supplementing solid lines should be installed adjacent to the solid line. See inset in Figure 3B-15B for placement.

**Legend**

-  mono-directional white RPM
-  bidirectional yellow RPM
-  Direction of travel

**Table A**

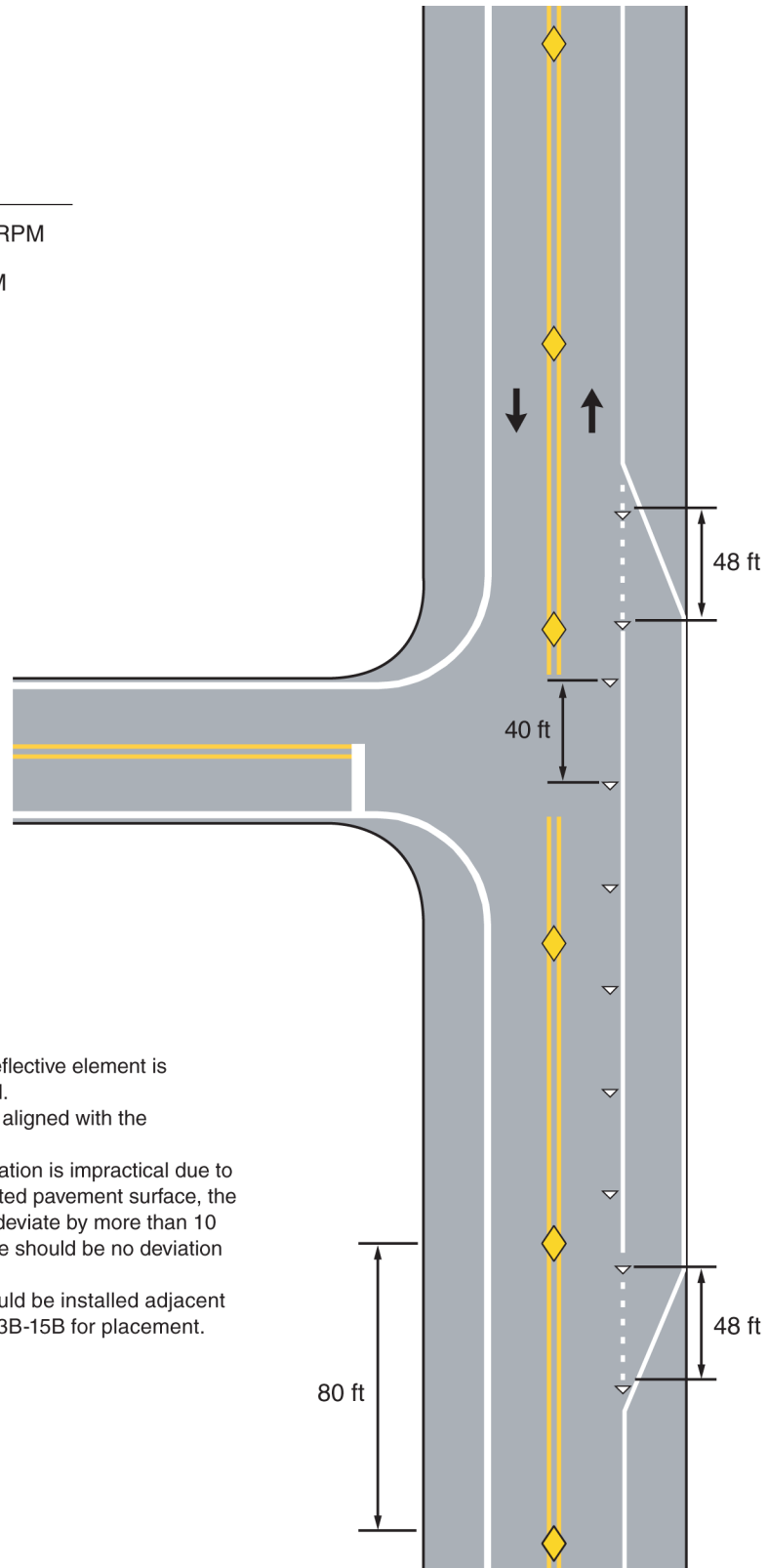
Posted or 85 <sup>th</sup> Percentile Speed (MPH)	Buffer Distance (ft)
30	240
35	280
40	320
45	360
50	400
55	440
60	480
65	520



**Figure 3B-15G. Example of Raised Pavement Marker (RPM) Application for Bypass Lane (Delaware Revision)**

**Legend**

- △ mono-directional white RPM
- ◇ bidirectional yellow RPM
- ↑ Direction of travel






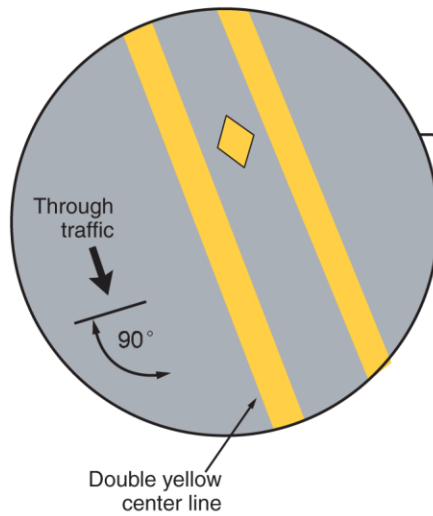
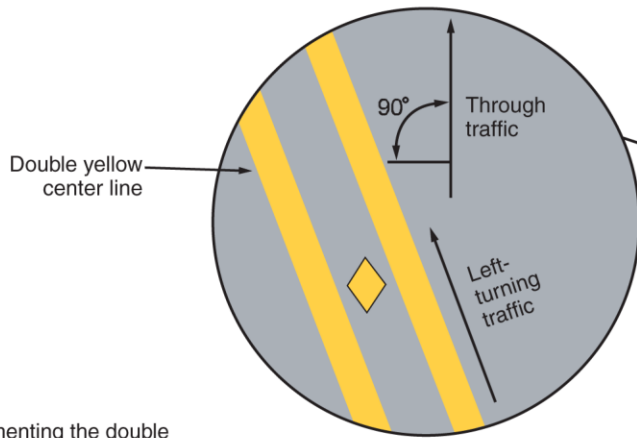
**General Notes:**

1. RPMs should be aligned so that the reflective element is perpendicular to the direction of travel.
2. The centerline of the RPMs should be aligned with the centerline of the broken lane lines.
3. In cases where the preferred RPM location is impractical due to construction joint spacing or deteriorated pavement surface, the longitudinal RPM spacing should not deviate by more than 10 percent from the typical spacing. There should be no deviation from the preferred lateral position.
4. RPMs supplementing solid lines should be installed adjacent to the solid line. See inset in Figure 3B-15B for placement.

**Figure 3B-15H. Example of Raised Pavement Marker (RPM) Application for Left -Turn Lane with Flush Median (Delaware Revision)**

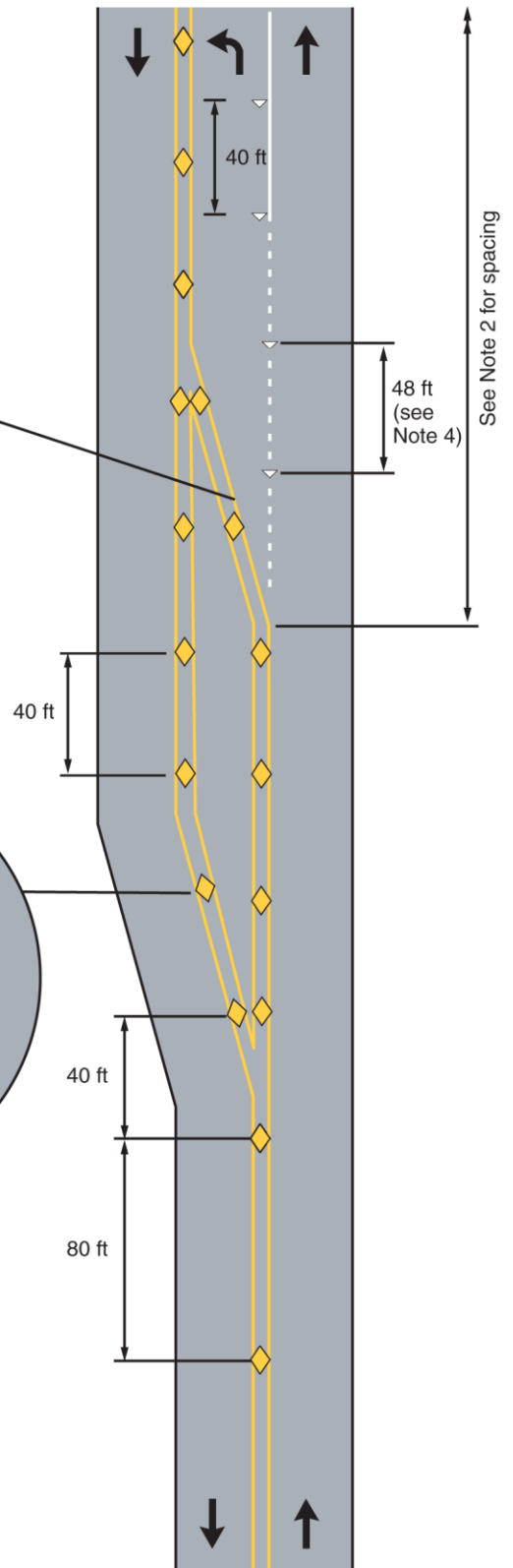
**Legend**

-  mono-directional white RPM
-  bidirectional yellow RPM
-  Direction of travel



**Notes:**

1. RPMs supplementing the double yellow center line should be installed between the two lines and oriented as shown in the details.
2. RPMs supplementing the double yellow center line along the length of the left-turn lane and taper should be spaced 20 ft apart if  $A < 200$  ft. If  $A \geq 200$  ft, RPMs should be spaced 40 ft apart along the length of the left-turn lane and taper, where A is the length of full-width left-turn lane and taper.
3. In cases where the preferred RPM location is impractical due to construction joint spacing or deteriorated pavement surface, the longitudinal RPM spacing should not deviate by more than 10 percent from the typical spacing. There should be no deviation from the preferred lateral position.
4. RPM spacing for all dotted lane lines should be 48 ft.
5. RPMs supplementing solid lines should be installed adjacent to the solid line. See inset in Figure 3B-15B for placement.



10 *The spacing of raised pavement markers used to supplement or substitute for other types of longitudinal markings should correspond with the pattern of broken lines for which the markers supplement or substitute.*

**Standard:**

11 **The value of N cited in Sections 3B.12 through 3B.14 for the spacing of raised pavement markers shall equal the length of one line segment plus one gap of the broken lines used on the highway.**

**Option:**

12 For additional emphasis, retroreflective raised pavement markers may be spaced closer than described in Sections 3B.12 through 3B.14, as determined by engineering judgment or engineering study.

**Support:**

13 Figures 9-20 through 9-22 in the “Traffic Control Devices Handbook” (see Section 1A.11) contain additional information regarding the spacing of raised pavement markers on longitudinal markings.

### **Section 3B.12 Raised Pavement Markers as Vehicle Positioning Guides with Other Longitudinal Markings**

**Option:**

01 Retroreflective or internally illuminated raised pavement markers may be used as positioning guides with longitudinal line markings without necessarily conveying information to the road user about passing or lane-use restrictions. In such applications, markers may be positioned in line with or immediately adjacent to a single line marking, or positioned between the two lines of a double center line or double lane line marking.

**Guidance:**

02 *The spacing for such applications should be 2N, where N equals the length of one line segment plus one gap (see Section 3B.11).*

**Option:**

03 Where it is desired to alert the road user to changes in the travel path, such as on sharp curves or on transitions that reduce the number of lanes or that shift traffic laterally, the spacing may be reduced to N or less.

04 (DE Revision) Paragraph deleted.

### **Section 3B.13 Raised Pavement Markers Supplementing Other Markings**

**Guidance:**

01 (DE Revision) *The use of retroreflective or internally illuminated raised pavement markers for supplementing longitudinal line markings should comply with the following:*

**A. Lateral Positioning**

1. *When supplementing double line markings other than double yellow center lines, pairs of raised pavement markers placed laterally in line with or immediately outside of the two lines should be used.*
2. *When supplementing wide solid line markings, pairs of raised pavement markers placed laterally adjacent to each other should be used.*
3. *When supplementing wide dotted lane line markings, single raised pavement markers should be aligned with the centerline of the dotted lane line markings.*

**B. Longitudinal Spacing**

1. *When supplementing solid line markings, raised pavement markers at a spacing no greater than N (see Section 3B.11) should be used, except that when supplementing channelizing lines or edge line markings, a spacing of no greater than N/2 should be used.*
2. *When supplementing broken line markings, a spacing of N or 2N should be used depending on the application. However, when supplementing broken line markings identifying reversible lanes, a spacing of no greater than N should be used.*
3. *When supplementing dotted lane line markings, a spacing of 48 feet should be used.*
4. *When supplementing longitudinal line extension markings through at-grade intersections, one raised pavement marker for each short line segment should be used.*
5. *When supplementing line extensions through freeway interchanges, a spacing of no greater than N should be used.*

02 *Raised pavement markers should not supplement right-hand edge lines unless an engineering study or engineering judgment indicates the benefits of enhanced delineation of a curve or other location would outweigh possible impacts on bicycles using the shoulder, and the spacing of raised pavement markers on the right-hand edge is close enough to avoid misinterpretation as a broken line during wet night conditions.*

Option:

03 Raised pavement markers also may be used to supplement other markings such as channelizing islands, gore areas, approaches to obstructions, or wrong-way arrows.

04 **(DE Revision)** To improve the visibility of horizontal curves, center lines may be supplemented with retroreflective or internally illuminated raised pavement markers for the entire curved section as well as for a distance in advance of the curve that approximates 5 seconds of travel time (see Figures 3B-15D and 3B-15E).

### Section 3B.14 Raised Pavement Markers Substituting for Pavement Markings

#### Standard:

01 **(DE Revision)** Retroreflective or internally illuminated raised pavement markers, or non-retroreflective raised pavement markers supplemented by retroreflective or internally illuminated markers, **shall not** be substituted for markings of other types **along state-maintained roadways unless approved by DelDOT Traffic.**

Guidance:

02 *If used, the pattern of the raised pavement markers should simulate the pattern of the markings for which they substitute.*

#### Standard:

03 **If raised pavement markers are used to substitute for broken line markings, a group of three to five markers equally spaced at a distance no greater than  $N/8$  (see Section 3B.11) shall be used. If  $N$  is other than 40 feet, the markers shall be equally spaced over the line segment length (at  $1/2$  points for three markers, at  $1/3$  points for four markers, and at  $1/4$  points for five markers). At least one retroreflective or internally illuminated marker per group shall be used or a retroreflective or internally illuminated marker shall be installed midway in each gap between successive groups of non-retroreflective markers.**

04 **When raised pavement markers substitute for solid line markings, the markers shall be equally spaced at no greater than  $N/4$ , with retroreflective or internally illuminated units at a spacing no greater than  $N/2$ .**

Guidance:

05 *Raised pavement markers should not substitute for right-hand edge line markings unless an engineering study or engineering judgment indicates the benefits of enhanced delineation of a curve or other location would outweigh possible impacts on bicycles using the shoulder, and the spacing of raised pavement markers on the right-hand edge line is close enough to avoid misinterpretation as a broken line during wet night conditions.*

#### Standard:

06 **When raised pavement markers substitute for dotted lines, they shall be spaced at no greater than  $N/4$ , with not less than one raised pavement marker per dotted line segment. At least one raised marker every  $N$  shall be retroreflective or internally illuminated.**

Option:

07 When substituting for wide lines, raised pavement markers may be placed laterally adjacent to each other to simulate the width of the line.

### Section 3B.15 Transverse Markings

#### Standard:

01 **Transverse markings, which include shoulder markings, word and symbol markings, arrows, stop lines, yield lines, crosswalk lines, speed measurement markings, speed reduction markings, speed hump markings, parking space markings, and others, shall be white unless otherwise provided in this Manual.**

Guidance:

02 *Because of the low approach angle at which pavement markings are viewed, transverse lines should be proportioned to provide visibility at least equal to that of longitudinal lines.*



**Section 3B.16 Stop and Yield Lines**

*Guidance:*

01 *Stop lines should be used to indicate the point behind which vehicles are required to stop in compliance with a traffic control signal.*

01A *(DE Revision) Stop lines should be installed on all approaches to signalized intersections.*

01B *(DE Revision) Stop lines should be installed on all stop-controlled approaches with crosswalks.*

01C *(DE Revision) Except as provided in Paragraph 1D, stop lines should be installed on all state-maintained stop-controlled approaches and on all stop-controlled approaches to state-maintained roadways.*

01D *(DE Revision) Stop lines should not be installed at the intersection of two subdivision streets unless a crosswalk is present or engineering judgment indicates such a need.*

**Option:**

02 Stop lines may be used to indicate the point behind which vehicles are required to stop in compliance with a STOP (R1-1) sign, a Stop Here For Pedestrians (R1-5b or R1-5c) sign, or some other traffic control device that requires vehicles to stop, except YIELD signs that are not associated with passive grade crossings.

03 Yield lines may be used to indicate the point behind which vehicles are required to yield in compliance with a YIELD (R1-2) sign or a Yield Here To Pedestrians (R1-5 or R1-5a) sign.

**Standard:**

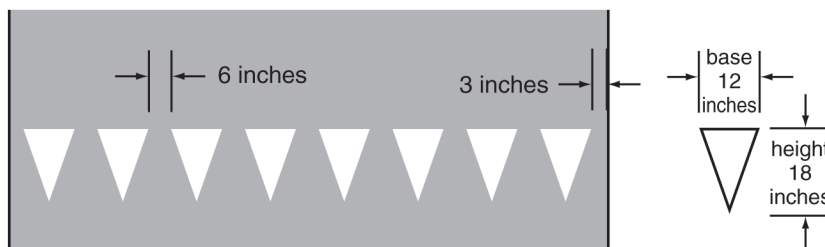
04 **Except as provided in Section 8B.28, stop lines shall not be used at locations where drivers are required to yield in compliance with a YIELD (R1-2) sign or a Yield Here To Pedestrians (R1-5 or R1-5a) sign or at locations on uncontrolled approaches where drivers are required by State law to yield to pedestrians.**

05 **Yield lines shall not be used at locations where drivers are required to stop in compliance with a STOP (R1-1) sign, a Stop Here For Pedestrians (R1-5b or R1-5c) sign, a traffic control signal, or some other traffic control device.**

06 **Stop lines shall consist of solid white lines extending across approach lanes to indicate the point at which the stop is intended or required to be made.**

07 **Yield lines (see Figure 3B-16) shall consist of a row of solid white isosceles triangles pointing toward approaching vehicles extending across approach lanes to indicate the point at which the yield is intended or required to be made.**

**Figure 3B-16. Recommended Yield Line Layouts  
(Delaware Revision)**



Note:  
Yield lines may be smaller than suggested when installed on much narrower, slow-speed facilities such as shared-use paths.

*Guidance:*

08 *(DE Revision)* Stop lines should be 16 inches wide except at grade crossings, where they should be 24 inches wide.

09 *(DE Revision)* The individual triangles comprising the yield line should have a base of 12 inches and a height of 18 inches. The space between the triangles should be 6 inches.

10 If used, stop and yield lines should be placed a minimum of 4 feet in advance of the nearest crosswalk line at controlled intersections, except for yield lines at roundabouts as provided for in Section 3C.04 and at midblock crosswalks. In the absence of a marked crosswalk, the stop line or yield line should be placed at the desired stopping or yielding point, but should not be placed more than 30 feet or less than 4 feet from the nearest edge of the intersecting traveled way.

11 Stop lines at midblock signalized locations should be placed at least 40 feet in advance of the nearest signal indication (see Section 4D.14).

12 If yield or stop lines are used at a crosswalk that crosses an uncontrolled multi-lane approach, the yield lines or stop lines should be placed 20 to 50 feet in advance of the nearest crosswalk line, and parking should be prohibited in the area between the yield or stop line and the crosswalk (see Figure 3B-17).

**Standard:**

13 **If yield (stop) lines are used at a crosswalk that crosses an uncontrolled multi-lane approach, Yield Here To (Stop Here For) Pedestrians (R1-5 series) signs (see Section 2B.11) shall be used.**

*Guidance:*

14 *(DE Revision)* Yield (stop) lines and Yield Here To (Stop Here For) Pedestrians signs should not be used in advance of crosswalks that cross an approach to or departure from a roundabout. Yield lines should not be used in advance of crosswalks across uncontrolled approaches to intersections.

14A *(DE Revision)* Yield lines should not be used in advance of crosswalks located across channelized right-turn lanes with YIELD signs.

14B *(DE Revision)* Yield (stop) lines should be used within median crossovers on the approach to the second roadway of a divided highway where the median width is greater than or equal to 50 feet and where the approach is controlled by a YIELD (STOP) sign (see Figure 2B-15).

*Option:*

14C *(DE Revision)* Yield (stop) lines may be used within median crossovers on the approach to the second roadway of a divided highway where the median width is greater than or equal to 30 feet and less than 50 feet and where the approach is controlled by a YIELD (STOP) sign where engineering judgment indicates such a need (see Figure 2B-15).

**Support:**

15 When drivers yield or stop too close to crosswalks that cross uncontrolled multi-lane approaches, they place pedestrians at risk by blocking other drivers' views of pedestrians and by blocking pedestrians' views of vehicles approaching in the other lanes.

*Guidance:*

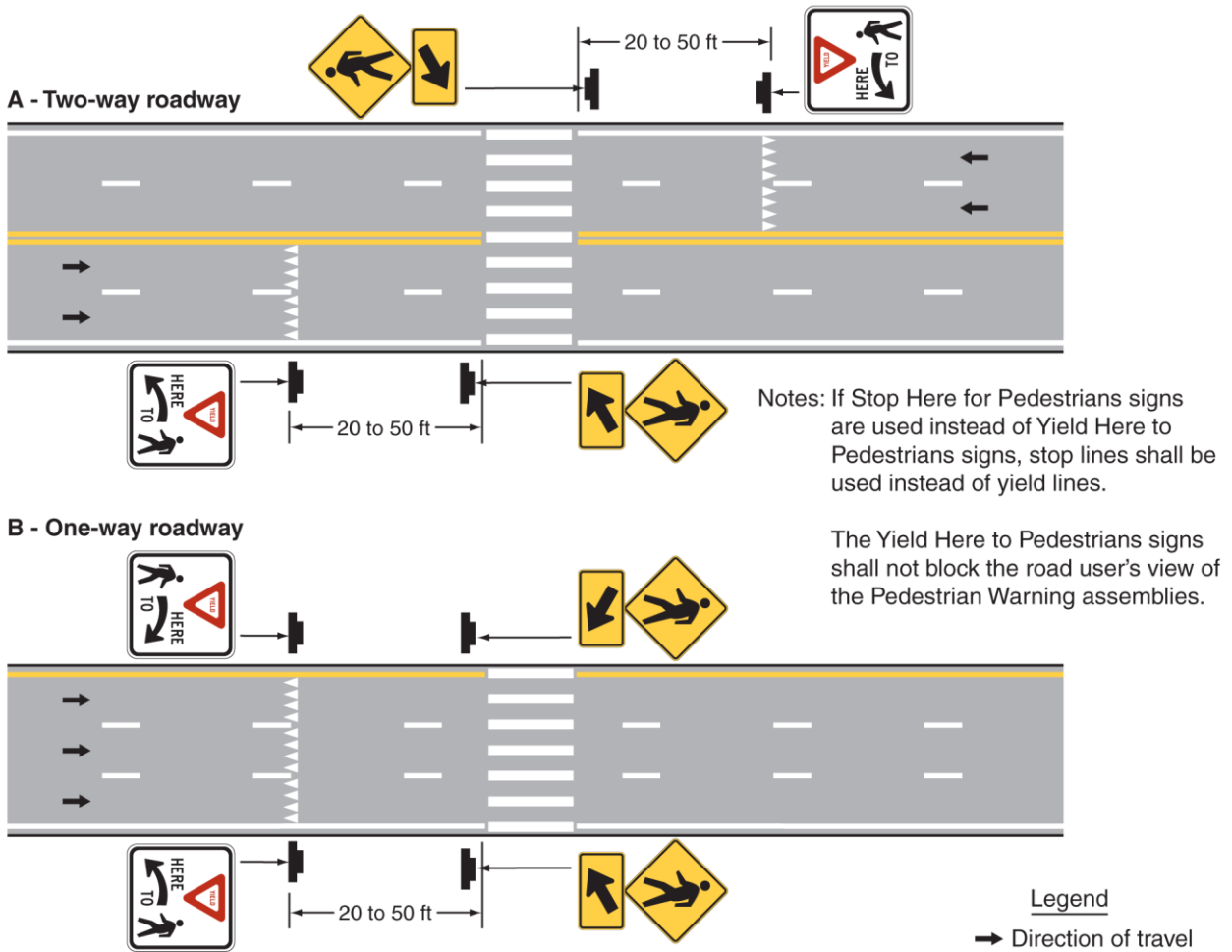
16 *(DE Revision)* Staggered stop and yield lines are discouraged and should not be used along state-maintained roadways unless approved by DelDOT Traffic.

**Support:**

17 Staggered stop lines and staggered yield lines can improve the driver's view of pedestrians, provide better sight distance for turning vehicles, and increase the turning radius for left-turning vehicles.

18 Section 8B.28 contains information regarding the use of stop lines and yield lines at grade crossings.

**Figure 3B-17. Examples of Yield Lines at Uncontrolled Midblock Crosswalks  
(Delaware Revision)**



**Section 3B.17 Do Not Block Intersection Markings**

Option:

01 Do Not Block Intersection markings may be used to mark the edges of an intersection area that is in close proximity to a signalized intersection, railroad crossing, or other nearby traffic control that might cause vehicles to stop within the intersection and impede other traffic entering the intersection. If authorized by law, Do Not Block Intersection markings with appropriate signs may also be used at other locations.

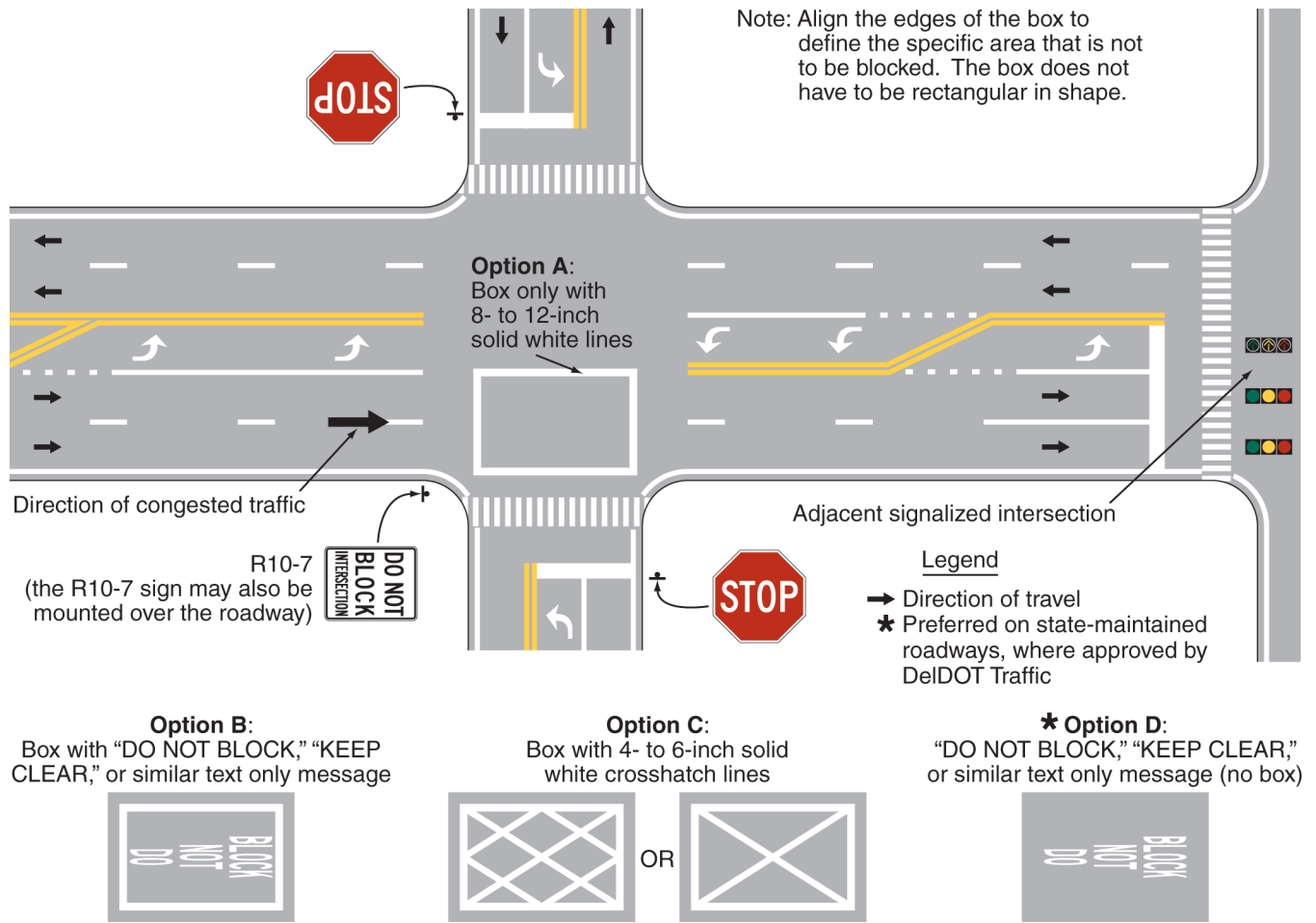
**Standard:**

02 **If used, Do Not Block Intersection markings (see Figure 3B-18) shall consist of one of the following alternatives:**

- A. Wide solid white lines that outline the intersection area that vehicles must not block;
- B. Wide solid white lines that outline the intersection area that vehicles must not block and a white word message such as DO NOT BLOCK or KEEP CLEAR;
- C. Wide solid white lines that outline the intersection area that vehicles must not block and white cross-hatching within the intersection area; or
- D. A white word message, such as DO NOT BLOCK or KEEP CLEAR, within the intersection area that vehicles must not block.

03 Do Not Block Intersection markings shall be accompanied by one or more Do Not Block Intersection (DRIVEWAY) (CROSSING) (R10-7) signs (see Section 2B.53), one or more Do Not Stop On Tracks (R8-8) signs (see Section 8B.09), or one or more similar signs.

**Figure 3B-18. Do Not Block Intersection Markings  
(Delaware Revision)**



**Guidance:**

03A (DE Revision) If approved by DelDOT Traffic for used along state-maintained roadways, Do Not Block Intersection markings should be as described in option D of Paragraph 2 and Figure 3B-18.

**Section 3B.18 Crosswalk Markings**

**Support:**

- 01 Crosswalk markings provide guidance for pedestrians who are crossing roadways by defining and delineating paths on approaches to and within signalized intersections, and on approaches to other intersections where traffic stops.
- 02 In conjunction with signs and other measures, crosswalk markings help to alert road users of a designated pedestrian crossing point across roadways at locations that are not controlled by traffic control signals or STOP or YIELD signs.
- 03 At non-intersection locations, crosswalk markings legally establish the crosswalk.

**Standard:**

04 When crosswalk lines are used, they shall consist of solid white lines that mark the crosswalk. They shall not be less than 6 inches or greater than 24 inches in width.

*Guidance:*

05 (DE Revision) *If 12-inch wide transverse lines are used to mark a temporary crosswalk or patterned pavement crosswalk or along non-state maintained roadways, the crosswalk width should be measured between the two lines (see Figure 3B-19).*

05A (DE Revision) *Crosswalk markings on roadways with a posted speed limit (or 85<sup>th</sup>-percentile speed) of 40 mph or greater and at locations with high pedestrian activity should be 10 feet wide. Crosswalk markings on other roadways should be 6 feet wide.*

05B (DE Revision) *Crosswalk markings on all approaches to an intersection with one or more roadways with a posted speed limit (or 85<sup>th</sup>-percentile speed) of 40 mph or greater or with high pedestrian activity should be 10 feet wide.*

06 *Crosswalk lines, if used on both sides of the crosswalk, should extend across the full width of pavement or to the edge of the intersecting crosswalk to discourage diagonal walking between crosswalks (see Figure 3B-19).*

07 *At locations controlled by traffic control signals or on approaches controlled by STOP or YIELD signs, crosswalk lines should be installed where engineering judgment indicates they are needed to direct pedestrians to the proper crossing path(s).*

08 *Crosswalk lines should not be used indiscriminately. An engineering study should be performed before a marked crosswalk is installed at a location away from a traffic control signal or an approach controlled by a STOP or YIELD sign. The engineering study should consider the number of lanes, the presence of a median, the distance from adjacent signalized intersections, the pedestrian volumes and delays, the average daily traffic (ADT), the posted or statutory speed limit or 85<sup>th</sup>-percentile speed, the geometry of the location, the possible consolidation of multiple crossing points, the availability of street lighting, and other appropriate factors.*

09 *New marked crosswalks alone, without other measures designed to reduce traffic speeds, shorten crossing distances, enhance driver awareness of the crossing, and/or provide active warning of pedestrian presence, should not be installed across uncontrolled roadways where the speed limit exceeds 40 mph and either:*

- A. *The roadway has four or more lanes of travel without a raised median or pedestrian refuge island and an ADT of 12,000 vehicles per day or greater; or*
- B. *The roadway has four or more lanes of travel with a raised median or pedestrian refuge island and an ADT of 15,000 vehicles per day or greater.*

*Support:*

10 Chapter 4F contains information on Pedestrian Hybrid Beacons. Section 4L.03 contains information regarding Warning Beacons to provide active warning of a pedestrian's presence. Section 4N.02 contains information regarding In-Roadway Warning Lights at crosswalks. Chapter 7D contains information regarding school crossing supervision.

*Guidance:*

11 *Because non-intersection pedestrian crossings are generally unexpected by the road user, warning signs (see Section 2C.50) should be installed for all marked crosswalks at non-intersection locations and adequate visibility should be provided by parking prohibitions.*

*Support:*

12 Section 3B.16 contains information regarding placement of stop line markings near crosswalk markings.

*Option:*

13 (DE Revision) Paragraph deleted.

14 (DE Revision) Paragraph deleted.

**Standard:**

15 **(DE Revision) If crosswalk markings along state-maintained roadways are used for permanent applications other than with patterned pavement or other aesthetic treatments, they shall consist of 24-inch wide solid white longitudinal lines separated by gaps of 24 inches (see Figure 3B-19).**

*Guidance:*

15A (DE Revision) *The design and placement of the lines and gaps should avoid the wheel paths if possible.*

15B (DE Revision) *When patterned pavement or other aesthetic treatments are used to depict crosswalks, 12-inch wide transverse solid white lines should be used to define the crosswalk.*

**Option:**

15C (DE Revision) Twelve-inch solid white transverse crosswalk markings may be used for temporary crosswalk installations (see Chapter 6F for additional guidance).

16 When an exclusive pedestrian phase that permits diagonal crossing of an intersection is provided at a traffic control signal, a marking as shown in Figure 3B-20 may be used for the crosswalk.

**Guidance:**

16A (DE Revision) Crosswalk markings accommodating diagonal pedestrian crossings are discouraged and should not be used along state-maintained roadways unless approved by DelDOT Traffic.

17 Crosswalk markings should be located so that the curb ramps are within the extension of the crosswalk markings.

**Support:**

18 Detectable warning surfaces mark boundaries between pedestrian and vehicular ways where there is no raised curb. Detectable warning surfaces are required by 49 CFR, Part 37 and by the Americans with Disabilities Act (ADA) where curb ramps are constructed at the junction of sidewalks and the roadway, for marked and unmarked crosswalks. Detectable warning surfaces contrast visually with adjacent walking surfaces, either light-on-dark, or dark-on-light. The “Americans with Disabilities Act Accessibility Guidelines for Buildings and Facilities (ADAAG)” (see Section 1A.11) contains specifications for design and placement of detectable warning surfaces.

**Section 3B.19 Parking Space Markings****Support:**

01 Marking of parking space boundaries encourages more orderly and efficient use of parking spaces where parking turnover is substantial. Parking space markings tend to prevent encroachment into fire hydrant zones, bus stops, loading zones, approaches to intersections, curb ramps, and clearance spaces for islands and other zones where parking is restricted. Examples of parking space markings are shown in Figure 3B-21.

**Standard:**

02 **Parking space markings shall be white.**

**Option:**

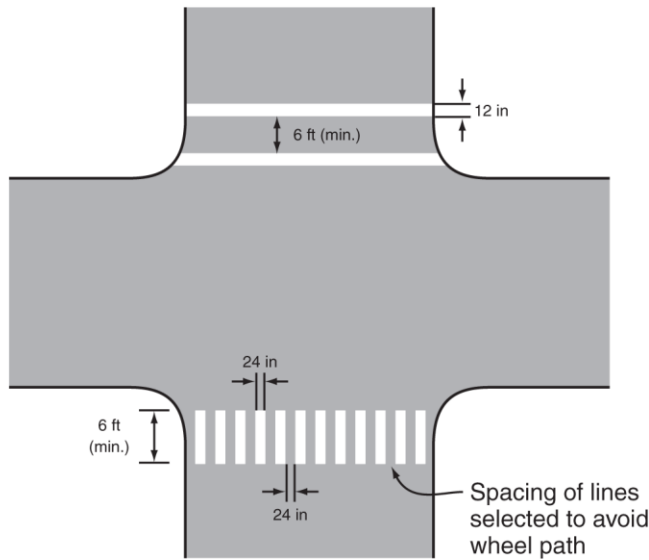
03 Blue lines may supplement white parking space markings of each parking space designated for use only by persons with disabilities.

**Support:**

04 Additional parking space markings for the purpose of designating spaces for use only by persons with disabilities are discussed in Section 3B.20 and illustrated in Figure 3B-22. The design and layout of accessible parking spaces for persons with disabilities is provided in the “Americans with Disabilities Act Accessibility Guidelines (ADAAG)” (see Section 1A.11).

04A (DE Revision) Regulations regarding stopping, standing and parking along state-maintained roadways are provided in §4178, §4179, §4180, and §4183 of Title 21 of the Delaware Code.

**Figure 3B-19. Examples of Crosswalk Markings  
(Delaware Revision)**

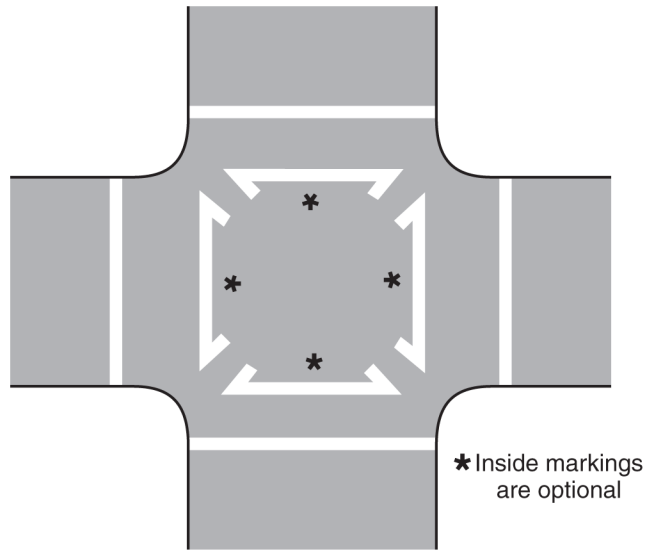


Notes:

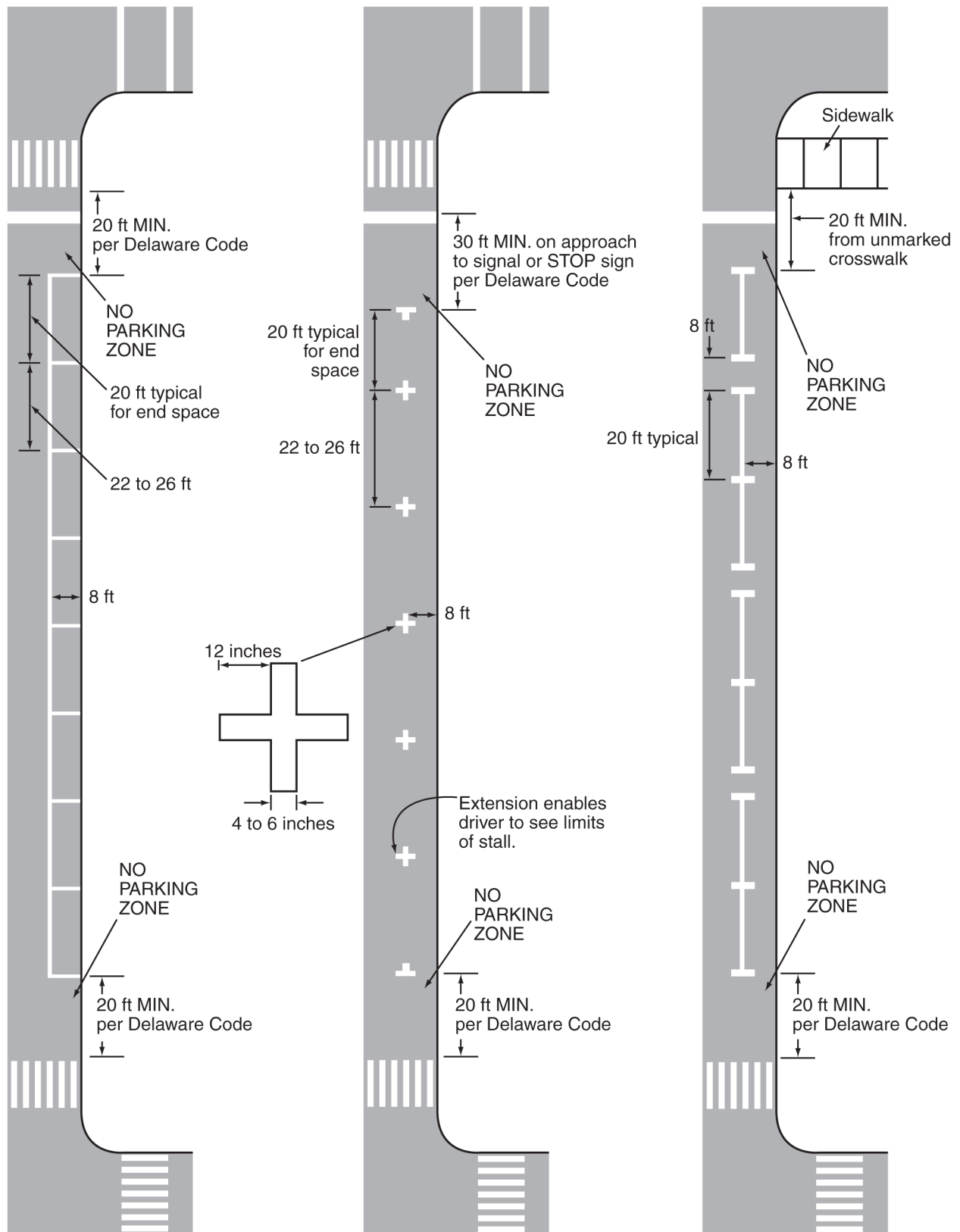
Transverse crosswalks should be used to delineate patterned and brick crosswalks.

Transverse crosswalks may also be used for temporary crosswalks and on non-state maintained roadways.

**Figure 3B-20. Example of Crosswalk Markings  
for an Exclusive Pedestrian Phase  
that Permits Diagonal Crossing**

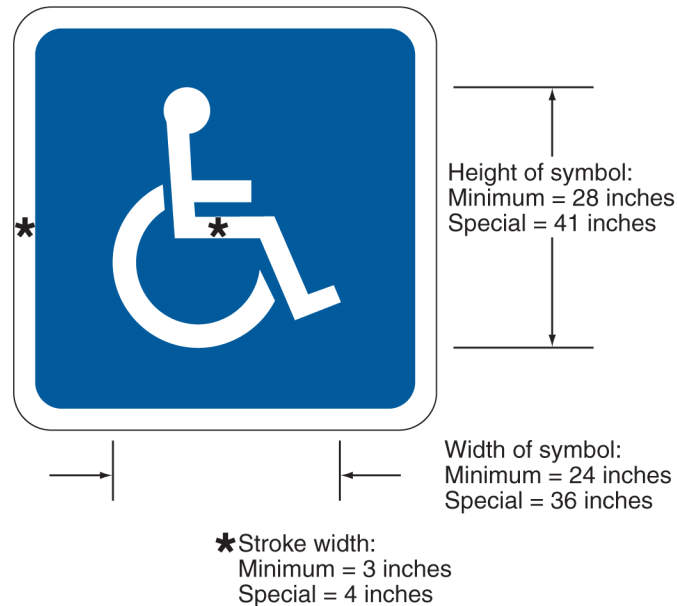


**Figure 3B-21. Examples of Parking Space Markings  
(Delaware Revision)**





**Figure 3B-22. International Symbol of Accessibility Parking Space Marking**



Note: Blue background and white border are optional

### Section 3B.20 Pavement Word, Symbol, and Arrow Markings

#### Support:

01 Word, symbol, and arrow markings on the pavement are used for the purpose of guiding, warning, or regulating traffic. These pavement markings can be helpful to road users in some locations by supplementing signs and providing additional emphasis for important regulatory, warning, or guidance messages, because the markings do not require diversion of the road user's attention from the roadway surface. Symbol messages are preferable to word messages. Examples of standard word and arrow pavement markings are shown in Figures 3B-23 and 3B-24.

#### Option:

02 Word, symbol, and arrow markings, including those contained in the "Standard Highway Signs and Markings" book (see Section 1A.11), may be used as determined by engineering judgment to supplement signs and/or to provide additional emphasis for regulatory, warning, or guidance messages. Among the word, symbol, and arrow markings that may be used are the following:

#### A. Regulatory:

1. STOP
2. YIELD
3. RIGHT (LEFT) TURN ONLY
4. 25 MPH
5. Lane-use and wrong-way arrows
6. Diamond symbol for HOV lanes
7. Other preferential lane word markings

#### B. Warning:

1. STOP AHEAD
2. YIELD AHEAD
3. SCHOOL XING
4. SIGNAL AHEAD
5. PED XING
6. SCHOOL

7. R X R
  8. BUMP
  9. HUMP
  10. Lane-reduction arrows
- C. Guide:
1. Route numbers (route shield pavement marking symbols and/or words such as I-81, US 40, STATE 135, or ROUTE 10)
  2. Cardinal directions (NORTH, SOUTH, EAST, or WEST)
  3. TO
  4. Destination names or abbreviations thereof

**Standard:**

- 03 **Word, symbol, and arrow markings shall be white, except as otherwise provided in this Section.**
- 04 **Pavement marking letters, numerals, symbols, and arrows shall be installed in accordance with the design details in the Pavement Markings chapter of the “Standard Highway Signs and Markings” book (see Section 1A.11).**

*Guidance:*

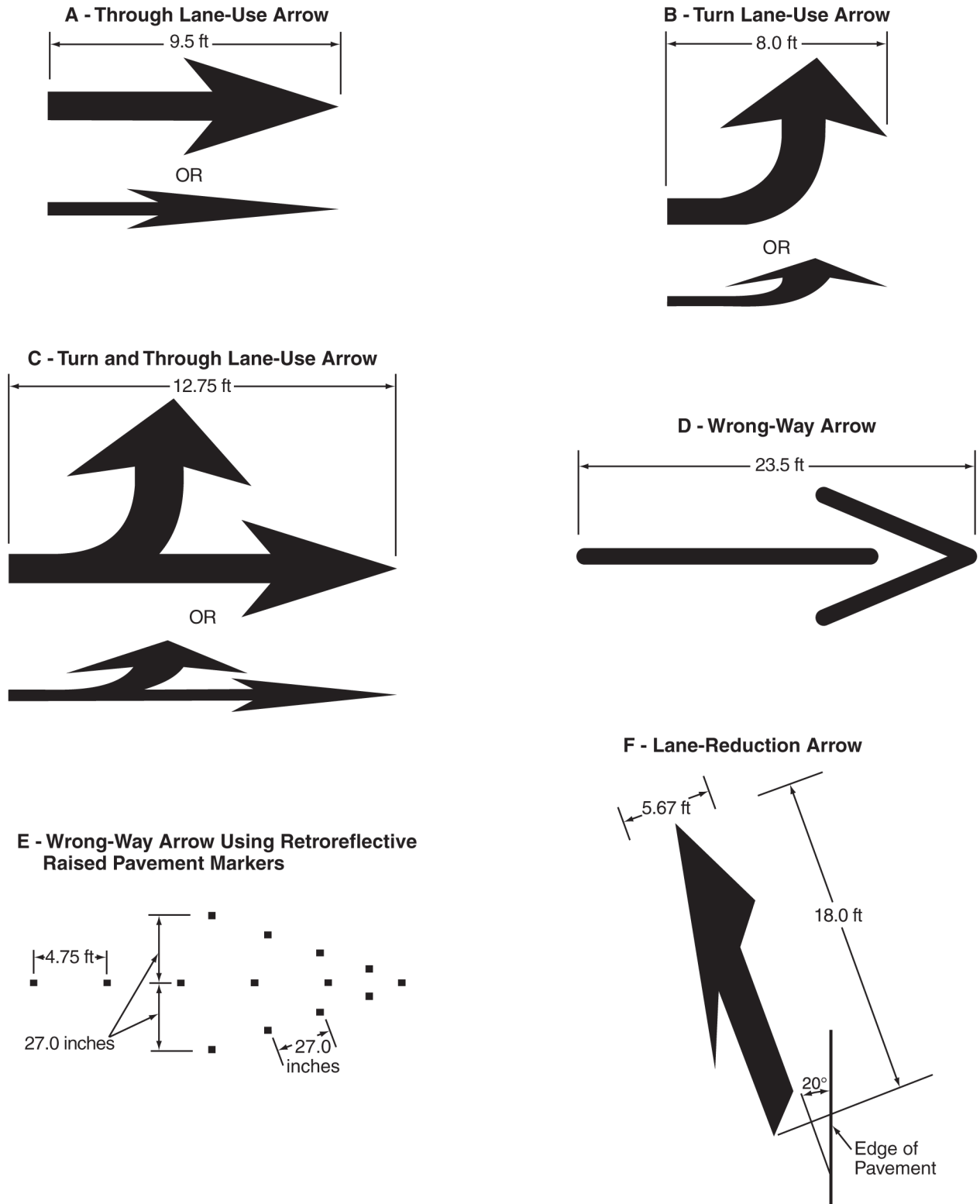
- 05 *Letters and numerals should be 6 feet or more in height.*
- 06 *Word and symbol markings should not exceed three lines of information.*
- 07 *If a pavement marking word message consists of more than one line of information, it should read in the direction of travel. The first word of the message should be nearest to the road user.*

---

**Figure 3B-23. Example of Elongated Letters for Word Pavement Markings**



**Figure 3B-24. Examples of Standard Arrows for Pavement Markings**



**Notes:**

1. Typical sizes for normal installation; sizes may be reduced approximately one-third for low-speed urban conditions; larger sizes may be needed for freeways, above average speeds, and other critical locations.
2. The narrow elongated arrow designs shown in Drawings A, B, and C are optional.
3. For proper proportion, see the Pavement Markings chapter of the "Standard Highway Signs and Markings" book (see Section 1A.11).

08 Except for the two opposing arrows of a two-way left-turn lane marking (see Figure 3B-7), the longitudinal space between word or symbol message markings, including arrow markings, should be at least four times the height of the characters for low-speed roads, but not more than ten times the height of the characters under any conditions.

09 The number of different word and symbol markings used should be minimized to provide effective guidance and avoid misunderstanding.

10 Except for the SCHOOL word marking (see Section 7C.03), pavement word, symbol, and arrow markings should be no more than one lane in width.

11 Pavement word, symbol, and arrow markings should be proportionally scaled to fit within the width of the facility upon which they are applied.

Option:

12 On narrow, low-speed shared-use paths, the pavement words, symbols, and arrows may be smaller than suggested, but to the relative scale.

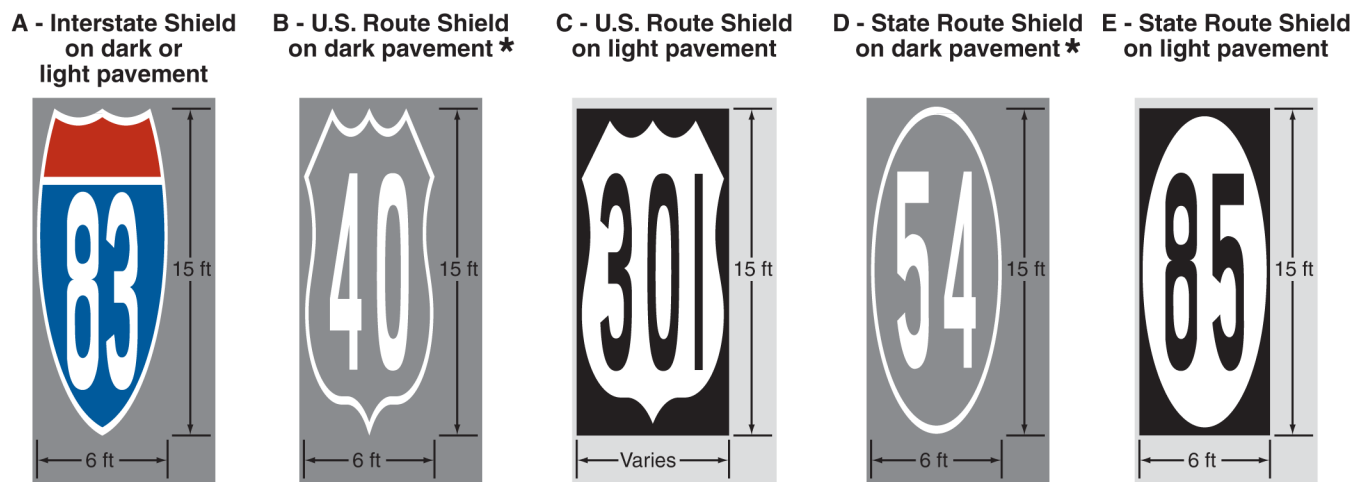
13 Pavement markings simulating Interstate, U.S., State, and other official highway route shield signs (see Figure 2D-3) with appropriate route numbers, but elongated for proper proportioning when viewed as a marking, may be used to guide road users to their destinations (see Figure 3B-25).

*Guidance:*

13A (DE Revision) Colored pavement markings displaying logos, emblems, symbols or patterns (other than those specifically permitted elsewhere in this Manual) should not be used, particularly in urban areas, or at/near intersections, so as to minimize diversion of attention from the roadway and other signs or pavement markings intended to convey regulatory, warning, or guidance information to motorists, consistent with Section 3A.01.

13B (DE Revision) If used along state-maintained roadways, pavement markings simulating route shield signs should be as shown in options B or D of Figure 3B-25. DeIDOT Traffic should be contacted for additional guidance regarding the installation of pavement markings simulating route shield signs along state-maintained roadways.

**Figure 3B-25. Examples of Elongated Route Shields for Pavement Markings (Delaware Revision)**



Notes:

1. See the "Standard Highway Signs and Markings" book for other sizes and details
2. Colors and elongated shapes simulating State route shield signs may be used for route shield pavement markings where appropriate

Legend

★ Preferred on state-maintained roadways, where approved by DeIDOT Traffic

## Figure 3B-26. Yield Ahead Triangle Symbols (Not Applicable in Delaware)

### Standard:

14 **Except at the ends of aisles in parking lots, the word STOP shall not be used on the pavement unless accompanied by a stop line (see Section 3B.16) and STOP sign (see Section 2B.05). At the ends of aisles in parking lots, the word STOP shall not be used on the pavement unless accompanied by a stop line.**

15 **The word STOP shall not be placed on the pavement in advance of a stop line, unless every vehicle is required to stop at all times.**

### Option:

16 **(DE Revision)** A YIELD AHEAD word pavement marking may be used on approaches to intersections where the approaching traffic will encounter a YIELD sign at the intersection.

### Standard:

17 **(DE Revision)** The YIELD AHEAD word pavement marking shall not be used unless a YIELD sign (see Section 2B.08) is in place at the intersection.

### Guidance:

18 *The International Symbol of Accessibility parking space marking (see Figure 3B-22) should be placed in each parking space designated for use by persons with disabilities.*

### Option:

19 A blue background with white border may supplement the wheelchair symbol as shown in Figure 3B-22.

### Support:

20 Lane-use arrow markings (see Figure 3B-24) are used to indicate the mandatory or permissible movements in certain lanes (see Figure 3B-27) and in two-way left-turn lanes (see Figure 3B-7).

### Guidance:

21 **(DE Revision)** *Lane-use arrow markings (see Figures 3B-11 and 3B-24) should be used in lanes designated for the exclusive use of a turning movement, including turn bays, except where engineering judgment determines that physical conditions or other markings (such as a dotted extension of the lane line through the taper into the turn bay) clearly discourage unintentional use of a turn bay by through vehicles. Lane-use arrow markings should also be used in lanes from which movements are allowed that are contrary to the normal rules of the road (see Drawing B of Figure 3B-13). For exclusive turn lanes with a full-width turn lane length less than 200 feet, one arrow should be placed at the upstream end of the full-width turn lane. For turn lanes with a full-width turn lane length equal to or greater than 200 feet and less than or equal to 500 feet, one arrow should be placed at the upstream end of the full-width turn lane and one arrow should be placed 30 feet in advance of the stop line or the edge of the intersecting roadway. For turn lanes with a full-width turn lane length greater than 500 feet, one arrow should be placed at the upstream end of the full-width turn lane, one arrow should be placed 30 feet in advance of the stop line or the edge of the intersecting roadway, and one arrow should be placed at one-half the length of the full-width turn lane (see Drawings A, B, D, and E of Figure 3B-11).*

21A **(DE Revision)** *If used on approaches to signalized intersection, lane-use arrow markings should not be installed on top of loop detectors.*

### Option:

22 **(DE Revision)** Paragraph deleted.

### Guidance:

23 *Where opposing offset channelized left-turn lanes exist, lane-use arrow markings should be placed near the downstream terminus of the offset left-turn lanes to reduce wrong-way movements (see Figure 2B-17).*

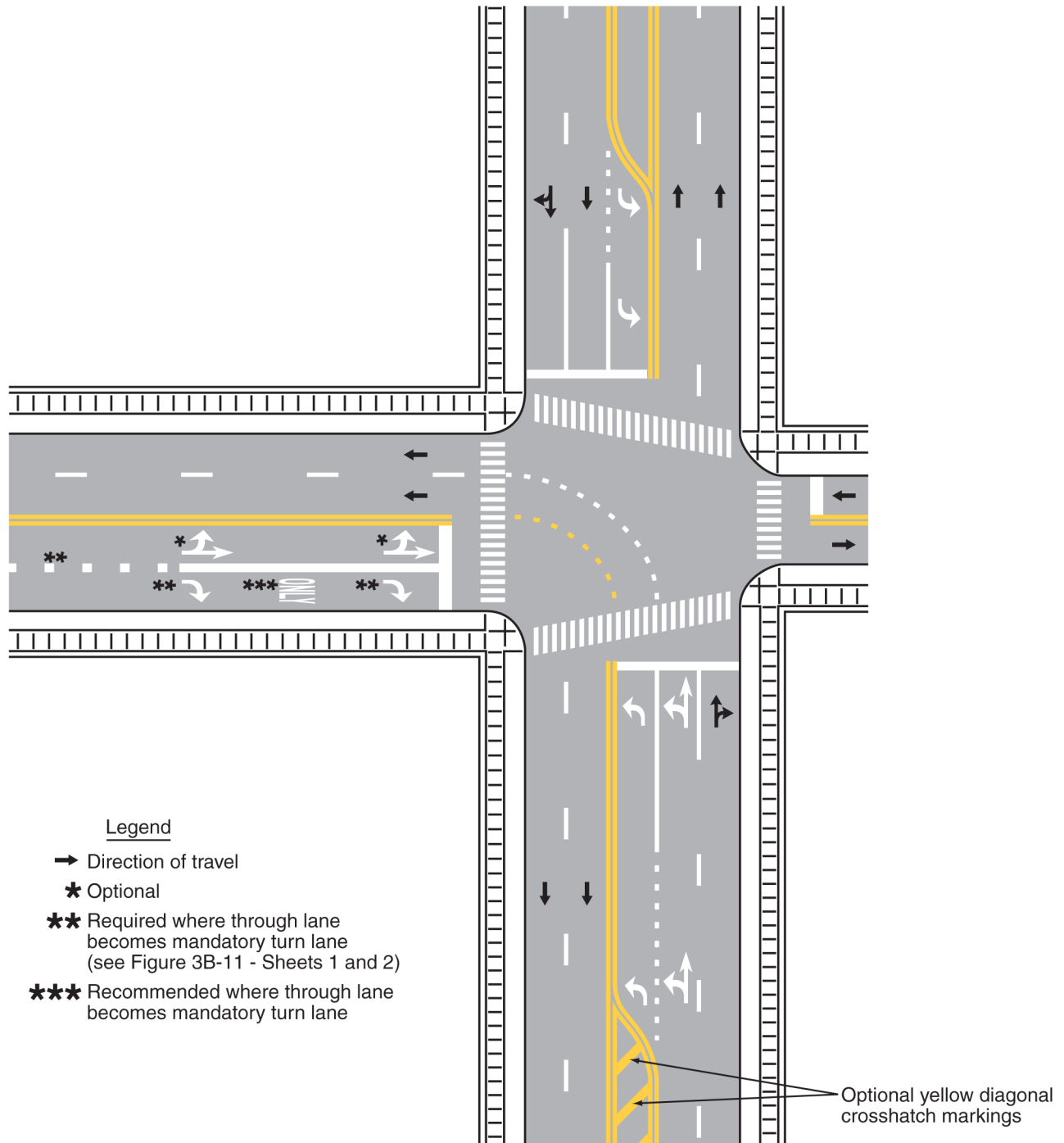
### Support:

24 An arrow at the downstream end of a turn lane can help to prevent wrong way movements.

**Standard:**

25 **(DE Revision)** Where through lanes approaching an intersection or added lanes from an upstream intersection become mandatory turn lanes, lane-use arrow markings (see Drawings A, B, and C of Figure 3B-11 and Figure 3B-24) shall be used and shall be accompanied by standard signs.

**Figure 3B-27. Examples of Lane-Use Control Word and Arrow Pavement Markings (Delaware Revision)**



*Guidance:*

26 *(DE Revision)* Where through lanes approaching an intersection *or added lanes from an upstream intersection* become mandatory turn lanes, *ONLY* word markings (see Figure 3B-23) should be used in addition to the required lane-use arrow markings and signs (see Sections 2B.19 and 2B.20). These markings and signs should be placed well in advance of the turn and should be repeated as necessary to prevent entrapment and to help the road user select the appropriate lane in advance of reaching a queue of waiting vehicles (see Drawings A, B, and C of Figure 3B-11).

## Option:

27 On freeways or expressways where a through lane becomes a mandatory exit lane, lane-use arrow markings may be used on the approach to the exit in the dropped lane and in an adjacent optional through-or-exit lane if one exists.

*Guidance:*

28 A two-way left-turn lane-use arrow pavement marking, with opposing arrows spaced as shown in Figure 3B-7, should be used at or just downstream from the beginning of a two-way left-turn lane.

## Option:

29 Additional two-way left-turn lane-use arrow markings may be used at other locations along a two-way left-turn lane where engineering judgment determines that such additional markings are needed to emphasize the proper use of the lane.

**Standard:**

30 **A single-direction lane-use arrow shall not be used in a lane bordered on both sides by yellow two-way left-turn lane longitudinal markings.**

31 **Lane-use, lane-reduction, and wrong-way arrow markings shall be designed as shown in Figure 3B-24 and in the “Standard Highway Signs and Markings” book (see Section 1A.11).**

## Option:

32 The *ONLY* word marking (see Figure 3B-23) may be used to supplement the lane-use arrow markings in lanes that are designated for the exclusive use of a single movement (see Figure 3B-27) or to supplement a preferential lane word or symbol marking (see Section 3D.01).

**Standard:**

33 **The *ONLY* word marking shall not be used in a lane that is shared by more than one movement.**

*Guidance:*

34 *(DE Revision)* Where a lane-reduction transition occurs on a roadway, the lane-reduction arrow markings shown in Drawing F in Figure 3B-24 should be used *as shown in Figures 3B-14, 3B-14A, 3B-14B, and 3B-14C*.

## Option:

35 Lane-reduction arrow markings may be used in long acceleration lanes based on engineering judgment.

*Guidance:*

36 Where crossroad channelization or ramp geometrics do not make wrong-way movements difficult, the appropriate lane-use arrow should be placed in each lane of an exit ramp near the crossroad terminal where it will be clearly visible to a potential wrong-way road user (see Figure 2B-18).

## Option:

37 The wrong-way arrow markings shown in Drawing D in Figure 3B-24 may be placed near the downstream terminus of a ramp as shown in Figures 2B-18 and 2B-19, or at other locations where lane-use arrows are not appropriate, to indicate the correct direction of traffic flow and to discourage drivers from traveling in the wrong direction.

### Section 3B.21 Speed Measurement Markings

Support:

01 A speed measurement marking is a transverse marking placed on the roadway to assist the enforcement of speed regulations.

**Standard:**

02 **(DE Revision) Speed measurement markings, if used, shall be white, and shall be 12 inches in width.**

02A **(DE Revision) Speed measurement marking shall not extend across the entire width of any travel lanes.**

Option:

03 (DE Revision) When at least one paved shoulder of sufficient width is available, speed measurement markings may be placed entirely on the shoulder (see Drawing A of Figure 3B-10). If no shoulder is available, speed measurement markings may be 24 inches long and centered on the center line and lane lines. In addition, a 24-inch long speed measurement marking may be placed on the edge line extending toward the center line or lane lines. Speed measurement markings may be installed at 1/4-mile intervals over a 1-mile length of roadway.

Advisory signs may be used in conjunction with these markings.

### Section 3B.22 Speed Reduction Markings

Support:

01 Speed reduction markings (see Figure 3B-28) are transverse markings that are placed on the roadway within a lane (along both edges of the lane) in a pattern of progressively reduced spacing to give drivers the impression that their speed is increasing. These markings might be placed in advance of an unexpectedly severe horizontal or vertical curve or other roadway feature where drivers need to decelerate prior to reaching the feature and where the desired reduction in speeds has not been achieved by the installation of warning signs and/or other traffic control devices.

*Guidance:*

02 *If used, speed reduction markings should be reserved for unexpected curves and should not be used on long tangent sections of roadway or in areas frequented mainly by local or familiar drivers, (e.g., school zones). If used, speed reduction markings should supplement the appropriate warning signs and other traffic control devices and should not substitute for these devices.*

**Standard:**

03 **If used, speed reduction markings shall be a series of white transverse lines on both sides of the lane that are perpendicular to the center line, edge line, or lane line. The longitudinal spacing between the markings shall be progressively reduced from the upstream to the downstream end of the marked portion of the lane.**

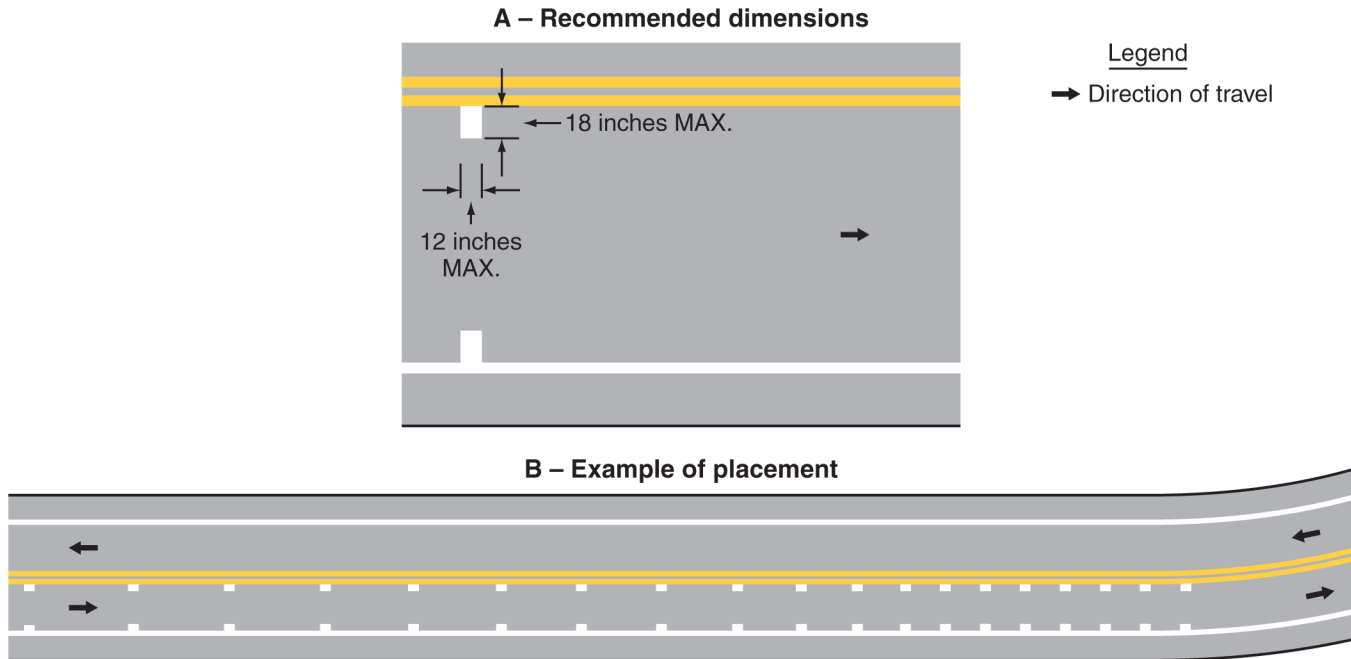
*Guidance:*

04 *Speed reduction markings should not be greater than 12 inches in width, and should not extend more than 18 inches into the lane.*

**Standard:**

05 **Speed reduction markings shall not be used in lanes that do not have a longitudinal line (center line, edge line, or lane line) on both sides of the lane.**



**Figure 3B-28. Example of the Application of Speed Reduction Markings**

### Section 3B.23 Curb Markings

Support:

01 Curb markings are most often used to indicate parking regulations or to delineate the curb.

**Standard:**

02 **Where curbs are marked to convey parking regulations in areas where curb markings are frequently obscured by snow and ice accumulation, signs shall be used with the curb markings except as provided in Paragraph 4.**

*Guidance:*

03 *Except as provided in Paragraph 4, when curb markings are used without signs to convey parking regulations, a legible word marking regarding the regulation (such as “No Parking” or “No Standing”) should be placed on the curb.*

03A *(DE Revision) Curb markings should not be used along state-maintained roadways to indicate parking regulations.*

**Standard:**

03B **Where curb markings are installed along state-maintained roadways by a local municipality, they shall be maintained by the local municipality.**

Option:

04 Curb markings without word markings or signs may be used to convey a general prohibition by statute of parking within a specified distance of a STOP sign, YIELD sign, driveway, fire hydrant, or crosswalk.

05 Local highway agencies may prescribe special colors for curb markings to supplement standard signs for parking regulation.

Support:

06 Since yellow and white curb markings are frequently used for curb delineation and visibility, it is advisable to establish parking regulations through the installation of standard signs (see Sections 2B.46 through 2B.48).

**Standard:**

07 **Where curbs are marked for delineation or visibility purposes, the colors shall comply with the general principles of markings (see Section 3A.05).**

*Guidance:*

08 *Retroreflective solid yellow markings should be placed on the approach ends of raised medians and curbs of islands that are located in the line of traffic flow where the curb serves to channel traffic to the right of the obstruction.*

09 *Retroreflective solid white markings should be used when traffic is permitted to pass on either side of the island.*

*Support:*

10 Where the curbs of the islands become parallel to the direction of traffic flow, it is not necessary to mark the curbs unless an engineering study indicates the need for this type of delineation.

11 Curbs at openings in a continuous median island need not be marked unless an engineering study indicates the need for this type of marking.

*Option:*

12 Retroreflective or internally illuminated raised pavement markers of the appropriate color may be placed on the pavement in front of the curb and/or on the top of curbed noses of raised medians and curbs of islands, as a supplement to or substitute for retroreflective curb markings used for delineation.

**Section 3B.24 Chevron and Diagonal Crosshatch Markings***Option:*

01 Chevron and diagonal crosshatch markings may be used to discourage travel on certain paved areas, such as shoulders, gore areas, flush median areas between solid double yellow center line markings or between white channelizing lines approaching obstructions in the roadway (see Section 3B.10 and Figure 3B-15), between solid double yellow center line markings forming flush medians or channelized travel paths at intersections (see Figures 3B-2 and 3B-5), buffer spaces between preferential lanes and general-purpose lanes (see Figures 3D-2 and 3D-4), and at grade crossings (see Part 8).

*Guidance:*

01A *(DE Revision) White chevron markings should be placed in the neutral area of exit ramp gores (see Figures 3B-8, 3B-8A, 3B-10 and 3B-10A).*

**Standard:**

02 **(DE Revision)** When crosshatch markings are used in paved areas that separate traffic flows in the same general direction, they shall be white and they shall be shaped as chevron markings, with the point of each chevron facing toward approaching traffic, as shown in Figure 3B-8, 3B-8A, 3B-10, 3B-10A, and Drawing C of Figure 3B-15.

03 **(DE Revision)** When crosshatch markings are used in paved areas that separate opposing directions of traffic, they shall be yellow diagonal markings that slant away from traffic in the adjacent travel lanes, as shown in Figure 3B-5 and Drawings A and B of Figure 3B-15.

04 When crosshatch markings are used on paved shoulders, they shall be diagonal markings that slant away from traffic in the adjacent travel lane. The diagonal markings shall be yellow when used on the left-hand shoulders of the roadways of divided highways and on the left-hand shoulders of one-way streets or ramps. The diagonal markings shall be white when used on right-hand shoulders.

*Guidance:*

05 *(DE Revision) The chevrons and diagonal lines used for crosshatch markings should be 12 inches wide along all roadways. The longitudinal spacing of the chevrons or diagonal lines should be 50 feet along interstates, expressways, and freeways and 25 feet along all other roadways. The chevrons and diagonal lines should form an angle of approximately 45 degrees with the longitudinal lines that they intersect.*

### Section 3B.25 Speed Hump Markings

#### Standard:

01 **If speed hump markings are used, they shall be a series of white markings placed on a speed hump to identify its location. If markings are used for a speed hump that does not also function as a crosswalk or speed table, the markings shall comply with Option A, B, or C shown in Figure 3B-29. If markings are used for a speed hump that also functions as a crosswalk or speed table, the markings shall comply with Option A or B shown in Figure 3B-30.**

#### Guidance:

01A *(DE Revision) If used along state-maintained roadways, speed hump markings should be as shown in Option A of Figure 3B-29 or Option A of Figure 3B-30.*

### Section 3B.26 Advance Speed Hump Markings

#### Option:

01 Advance speed hump markings (see Figure 3B-31) may be used in advance of speed humps or other engineered vertical roadway deflections such as dips where added visibility is desired or where such deflection is not expected.

02 Advance pavement wording such as BUMP or HUMP (see Section 3B.20) may be used on the approach to a speed hump either alone or in conjunction with advance speed hump markings. Appropriate advance warning signs may be used in compliance with Section 2C.29.

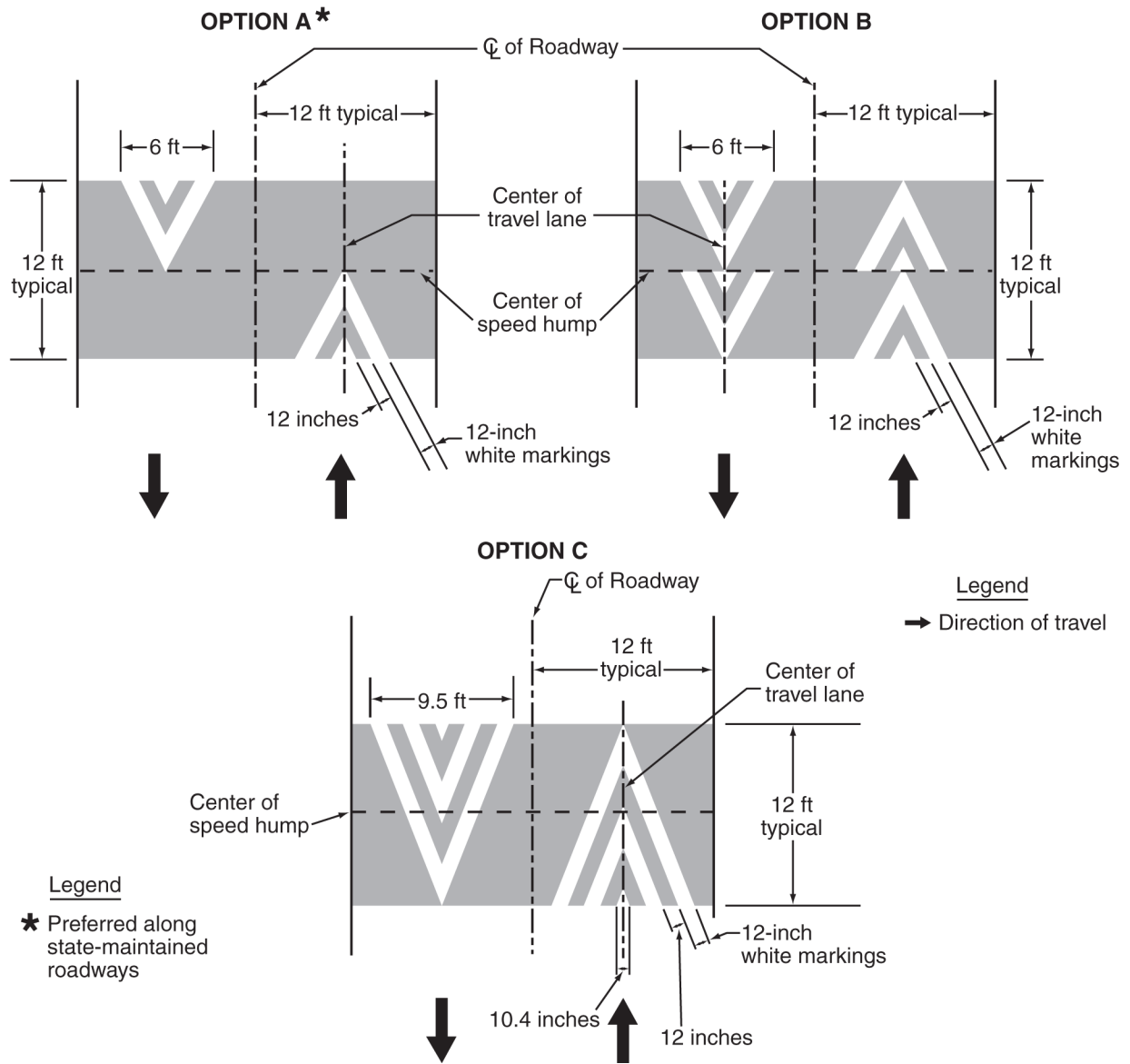
#### Standard:

03 **If advance speed hump markings are used, they shall be a series of eight white 12-inch transverse lines that become longer and are spaced closer together as the vehicle approaches the speed hump or other deflection. If advance markings are used, they shall comply with the detailed design shown in Figure 3B-31.**

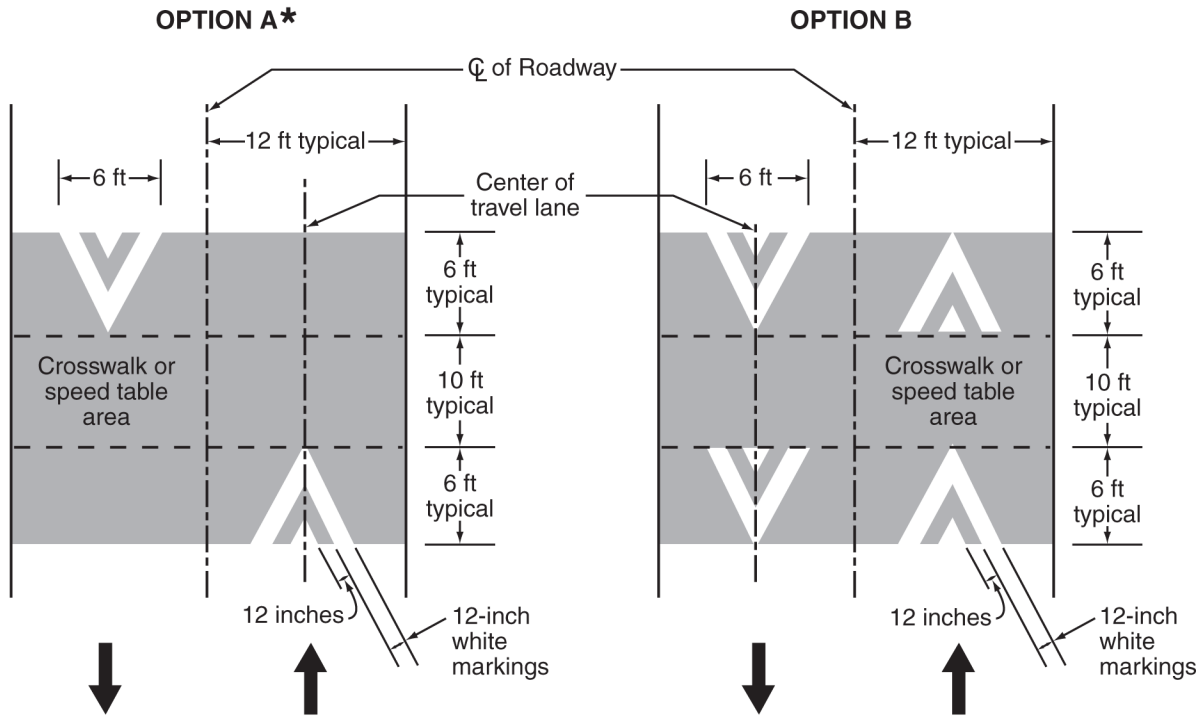
#### Guidance:

04 *If used, advance speed hump markings should be installed in each approach lane.*

**Figure 3B-29. Pavement Markings for Speed Humps without Crosswalks  
(Delaware Revision)**



**Figure 3B-30. Pavement Markings for Speed Tables or Speed Humps with Crosswalks  
(Delaware Revision)**

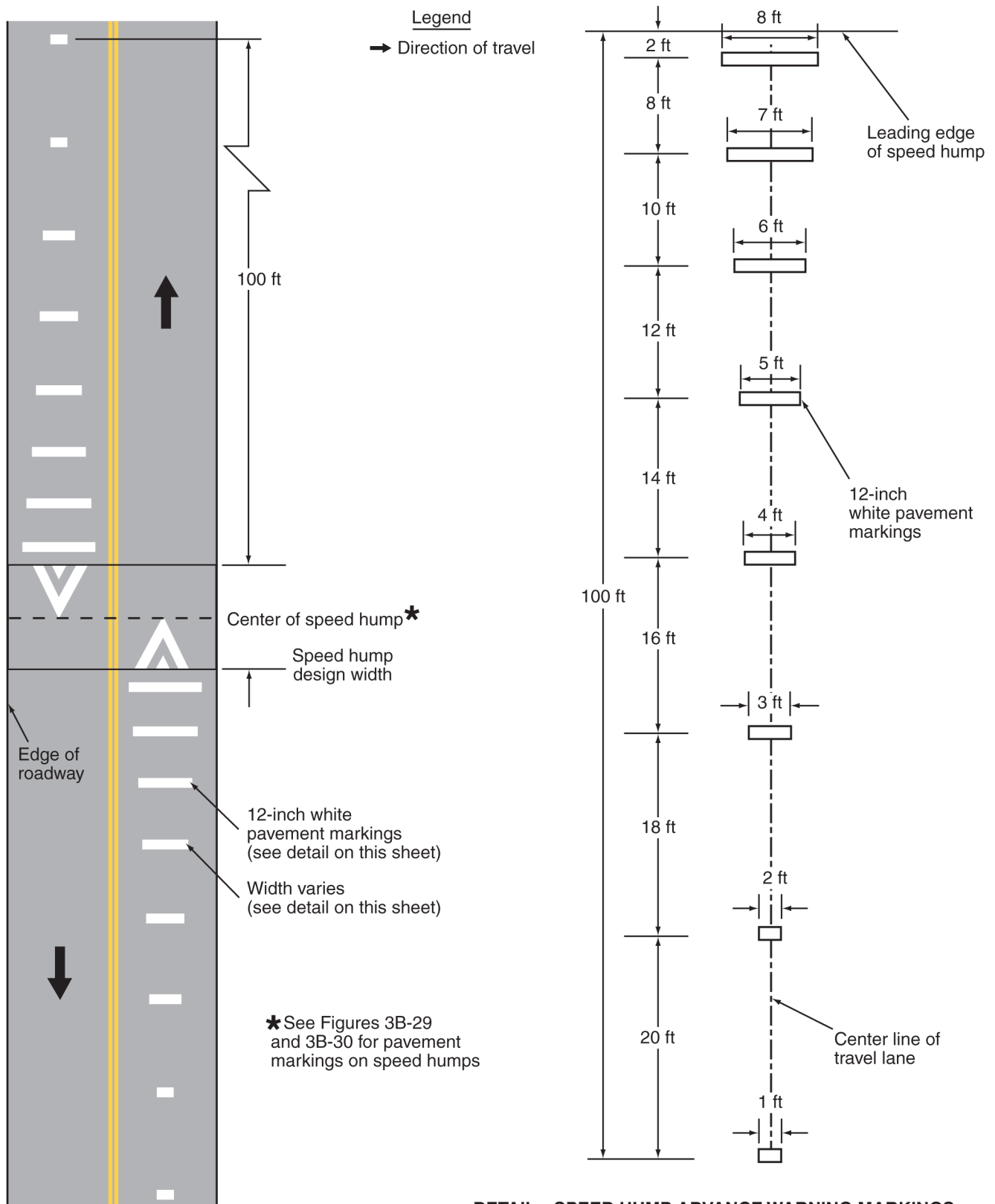


Note: Optional crosswalk lines are not shown in this figure

Legend

- Direction of travel
- \* Preferred along state-maintained roadways

**Figure 3B-31. Advance Warning Markings for Speed Humps**



## CHAPTER 3C. ROUNDABOUT MARKINGS

### Section 3C.01 General

#### Support:

01 A roundabout (see definition in Section 1A.13) is a specific type of circular intersection designed to control speeds and having specific traffic control features.

#### Guidance:

02 *Pavement markings and signing for a roundabout should be integrally designed to correspond to the geometric design and intended lane use of a roundabout.*

03 *Markings on the approaches to a roundabout and on the circular roadway should be compatible with each other to provide a consistent message to road users and should facilitate movement through the roundabout such that vehicles do not have to change lanes within the circulatory roadway in order to exit the roundabout in a given direction.*

#### Support:

04 Figure 3C-1 provides an example of the pavement markings for approach and circulatory roadways at a roundabout. Figure 3C-2 shows the options that are available for lane-use pavement marking arrows on approaches to roundabouts. Figures 3C-3 through 3C-14 illustrate examples of markings for roundabouts of various geometric and lane-use configurations.

05 Traffic control signals or pedestrian hybrid beacons (see Part 4) are sometimes used at roundabouts to facilitate the crossing of pedestrians or to meter traffic.

06 Section 8C.12 contains information about roundabouts that contain or are in close proximity to grade crossings.

### Section 3C.02 White Lane Line Pavement Markings for Roundabouts

#### Standard:

01 **Multi-lane approaches to roundabouts shall have lane lines.**

02 **A through lane on a roadway that becomes a dropped lane (mandatory turn lane) at a roundabout shall be marked with a dotted white lane line in accordance with Section 3B.04.**

#### Guidance:

03 *Multi-lane roundabouts should have lane line markings within the circulatory roadway to channelize traffic to the appropriate exit lane.*

#### Standard:

04 **Continuous concentric lane lines shall not be used within the circulatory roadway of roundabouts.**

#### Support:

05 Section 9C.04 contains information regarding bicycle lane markings at roundabouts.

### Section 3C.03 Edge Line Pavement Markings for Roundabout Circulatory Roadways

#### Guidance:

01 *A white edge line should be used on the outer (right-hand) side of the circulatory roadway.*

02 *(DE Revision) Where a white edge line is used for the circulatory roadway, it should be as follows (see Figure 3C-1):*

A. *A solid line adjacent to the splitter island, and*

B. *A wide dotted line consisting of 2-foot line segments and 2-foot gaps across the lane(s) entering the roundabout.*

#### Standard:

03 **Edge lines and edge line extensions shall not be placed across the exits from the circulatory roadway at roundabouts.**

*Guidance:*

04 (DE Revision) A yellow edge line *should* be placed around the inner (left-hand) edge of the circulatory roadway (see Figure 3C-1) and *should* be used to channelize traffic (see Drawing B of Figure 3C-4).

**Section 3C.04 Yield Lines for Roundabouts***Guidance:*

01 (DE Revision) A yield line (see Section 3B.16) *should* be used to indicate the point behind which vehicles are required to yield at the entrance to a roundabout (see Figure 3C-1). *Yield lines should be installed a minimum of 4 feet in advance of the nearest edge of the circulatory roadway.*

**Section 3C.05 Crosswalk Markings at Roundabouts****Standard:**

01 **Pedestrian crosswalks shall not be marked to or from the central island of roundabouts.**

*Guidance:*

02 *If pedestrian facilities are provided, crosswalks (see Section 3B.18) should be marked across roundabout entrances and exits to indicate where pedestrians are intended to cross.*

03 *Crosswalks should be a minimum of 20 feet from the edge of the circulatory roadway.*

**Support:**

04 Various arrangements of crosswalks at roundabouts are illustrated in the figures in this Chapter.

**Section 3C.06 Word, Symbol, and Arrow Pavement Markings for Roundabouts****Option:**

01 Lane-use arrows may be used on any approach to and within the circulatory roadway of any roundabout.

02 YIELD (word) and YIELD AHEAD (symbol or word) pavement markings (see Figure 3C-1) may be used on approaches to roundabouts.

03 Word and/or route shield pavement markings may be used on an approach to or within the circulatory roadway of a roundabout to provide route and/or destination guidance information to road users (see Figure 3C-14).

*Guidance:*

04 *Within the circulatory roadway of multi-lane roundabouts, normal lane-use arrows (see Section 3B.20 and Figure 3B-24) should be used.*

05 *On multi-lane approaches with double left-turn and/or double right-turn lanes, lane-use arrows as shown in Figures 3C-7 and 3C-8 should be used.*

**Option:**

06 If used on approaches to a roundabout, lane-use arrows may be either normal or fish-hook arrows, either with or without an oval symbolizing the central island, as shown in Figure 3C-2.

*Guidance:*

06A (DE Revision) *Lane-use arrows along the approaches to state-maintained roundabouts should be fish-hook arrows (see Figure 3C-2).*

**Section 3C.07 Markings for Other Circular Intersections****Support:**

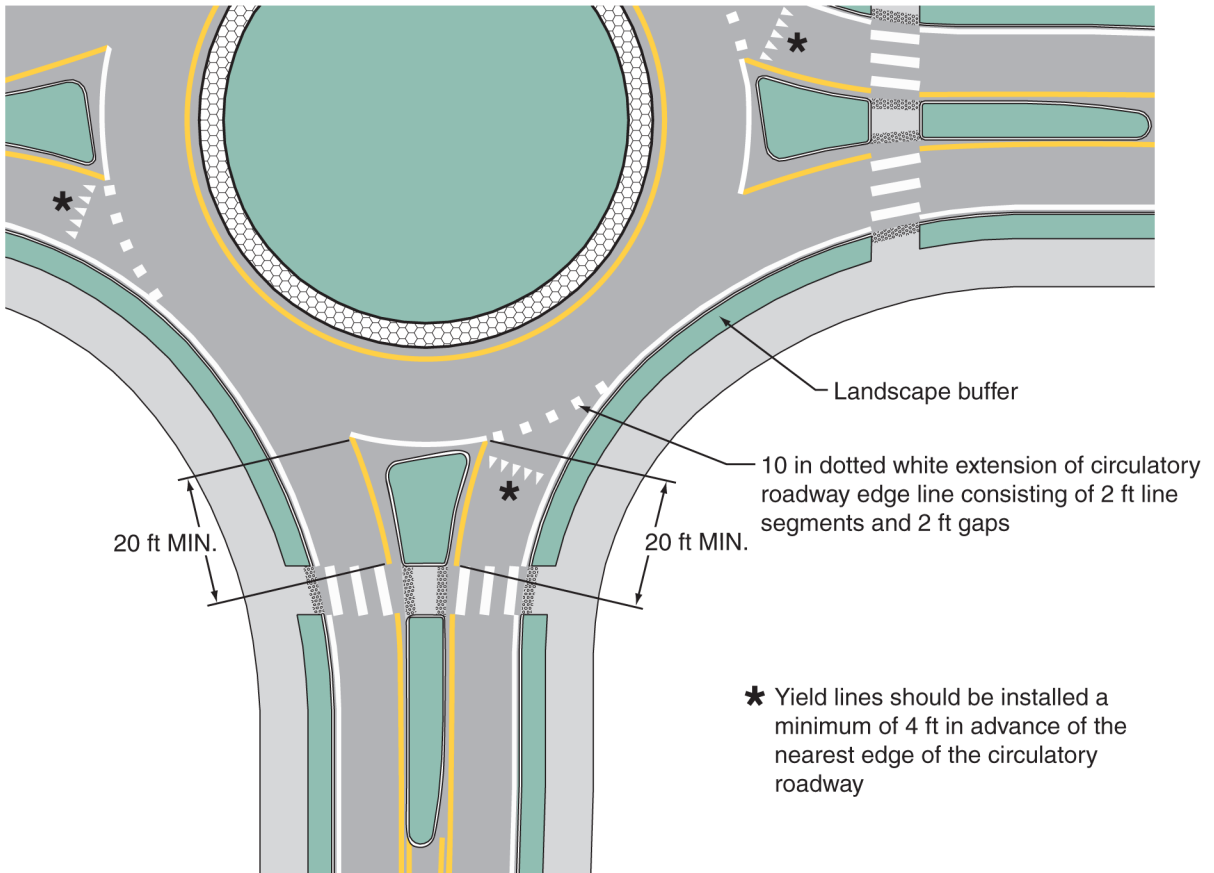
01 Other circular intersections include, but are not limited to, rotaries, traffic circles, and residential traffic calming designs.

**Option:**

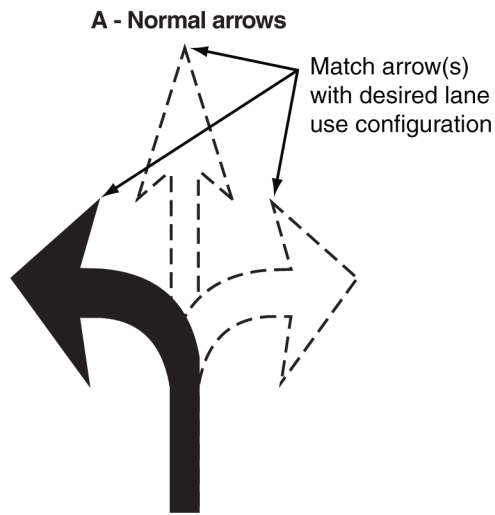
02 The markings shown in this Chapter may be used at other circular intersections if engineering judgment indicates that their presence will benefit drivers, pedestrians, or other road users.



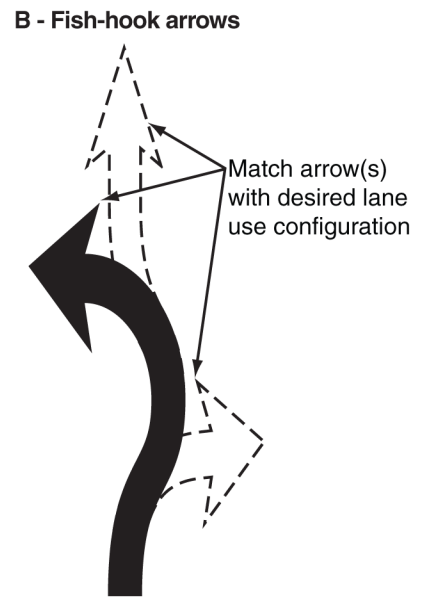
**Figure 3C-1. Example of Markings for Approach and Circulatory Roadways at a Roundabout  
(Delaware Revision)**



**Figure 3C-2. Lane-Use Arrow Pavement Marking Options for Roundabout Approaches  
(Delaware Revision)**

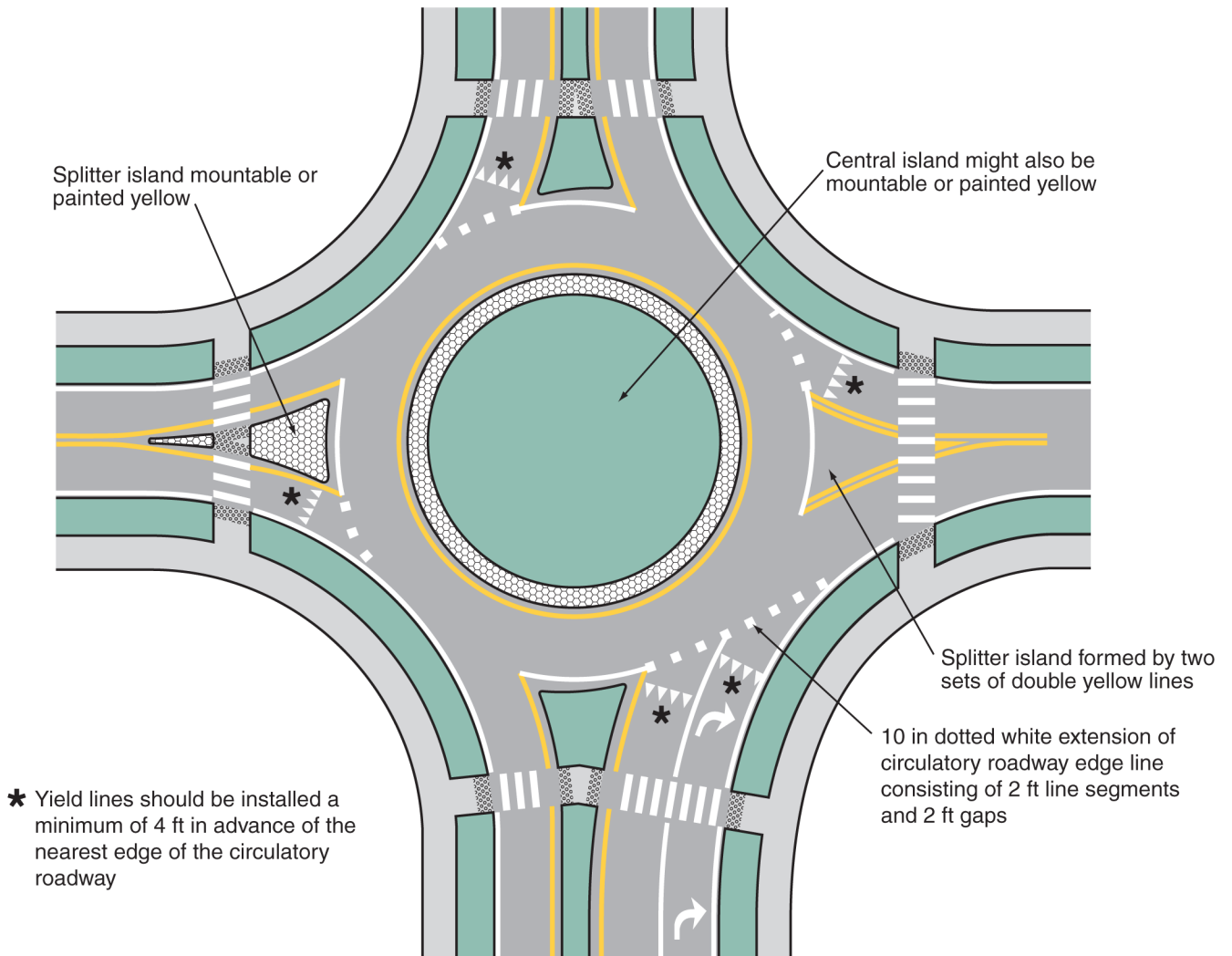


Installed within circulatory  
roadway at state-maintained  
multi-lane roundabouts

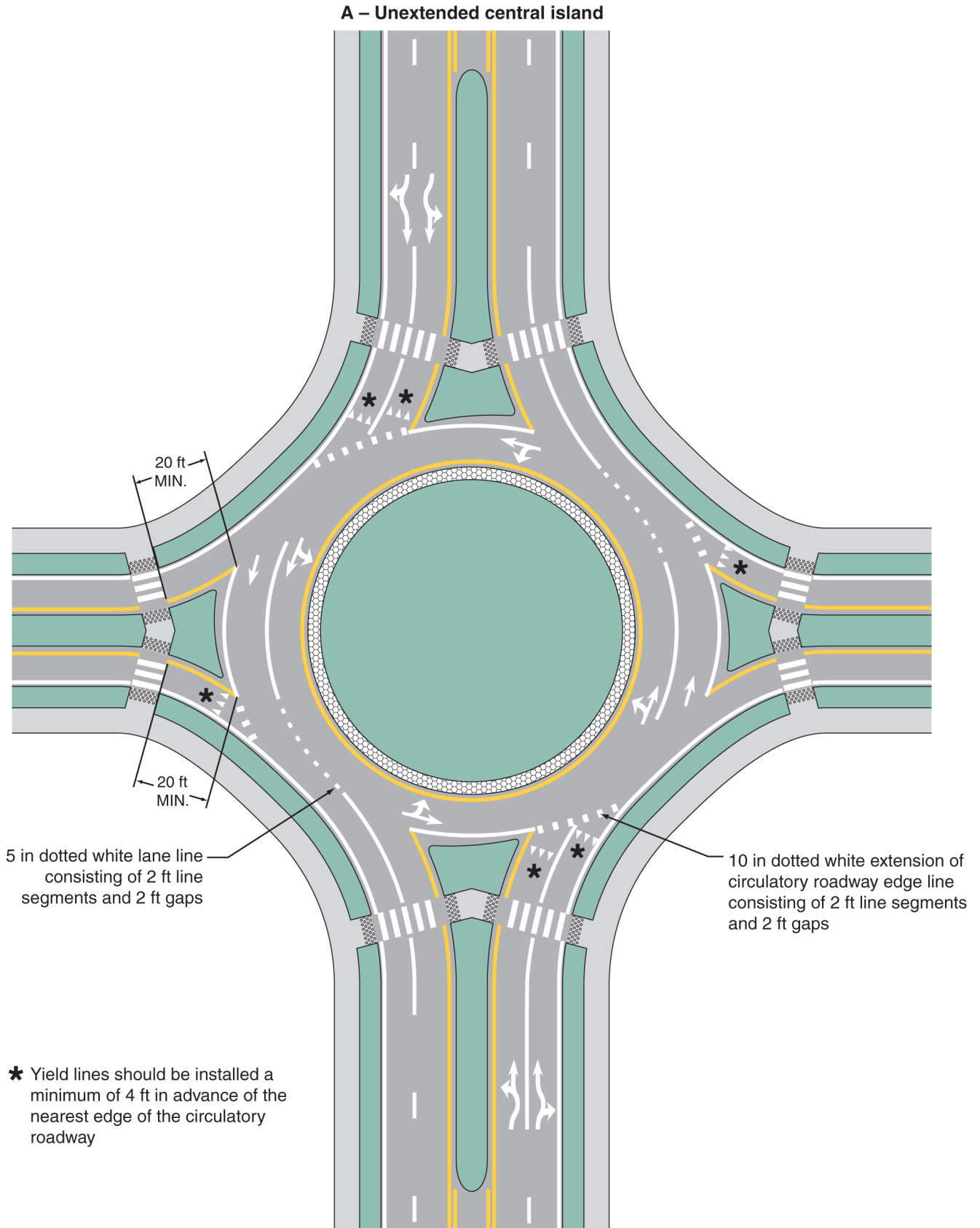


Installed along multi-lane  
approaches to state-maintained  
multi-lane roundabouts

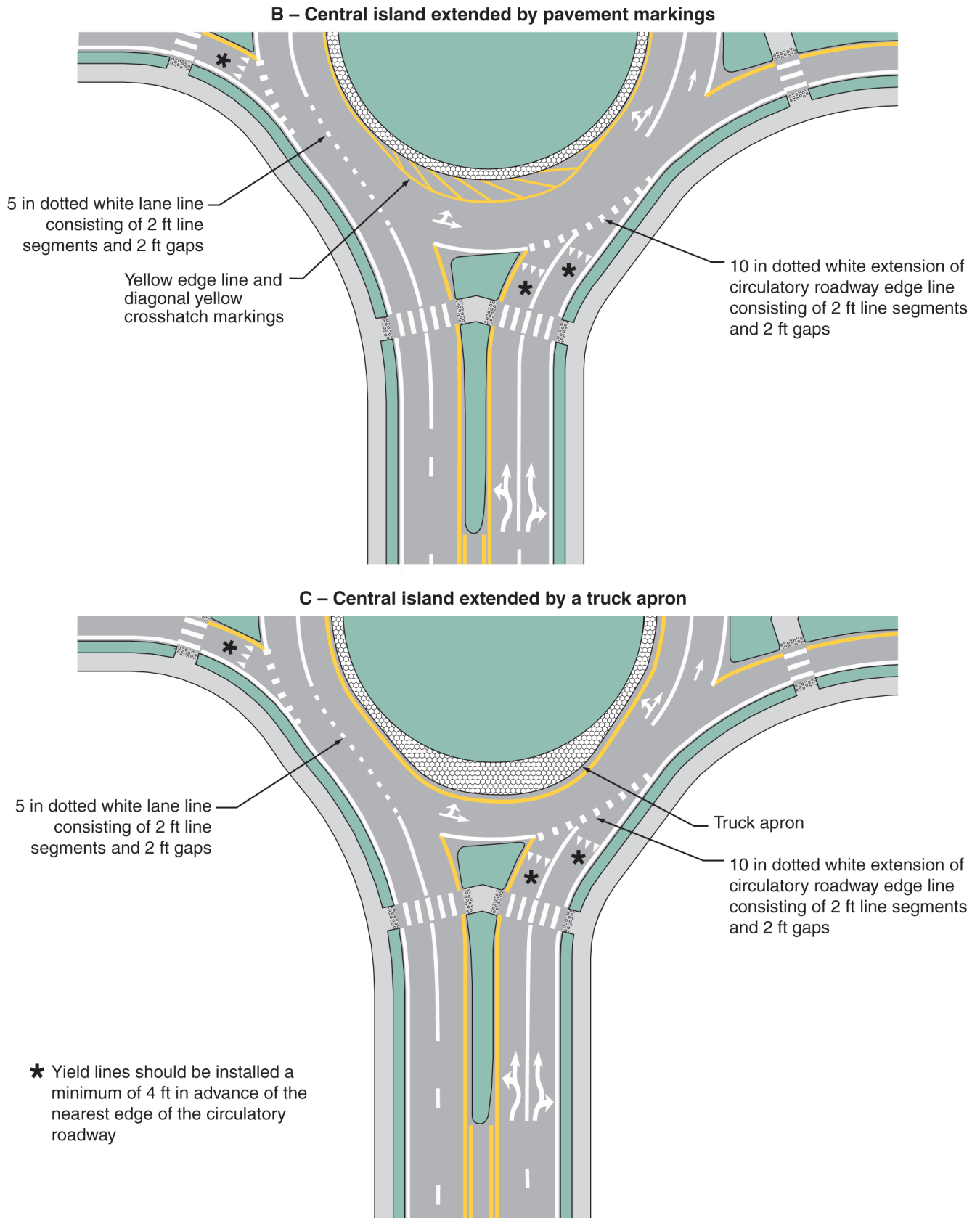
**Figure 3C-3. Example of Markings for a One-Lane Roundabout  
(Delaware Revision)**



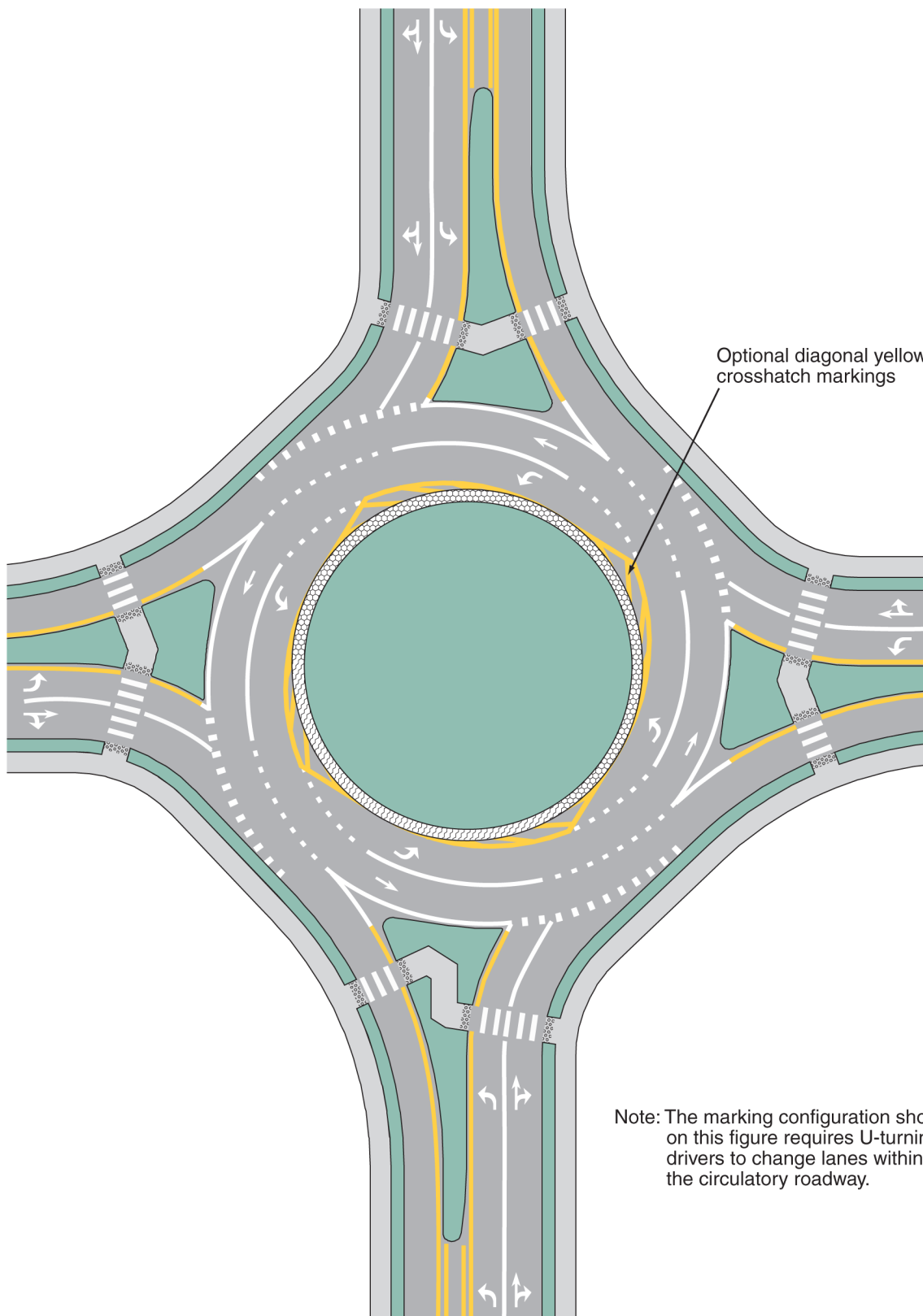
**Figure 3C-4. Example of Markings for a Two-Lane Roundabout with One- and Two-Lane Approaches (Sheet 1 of 2)  
(Delaware Revision)**



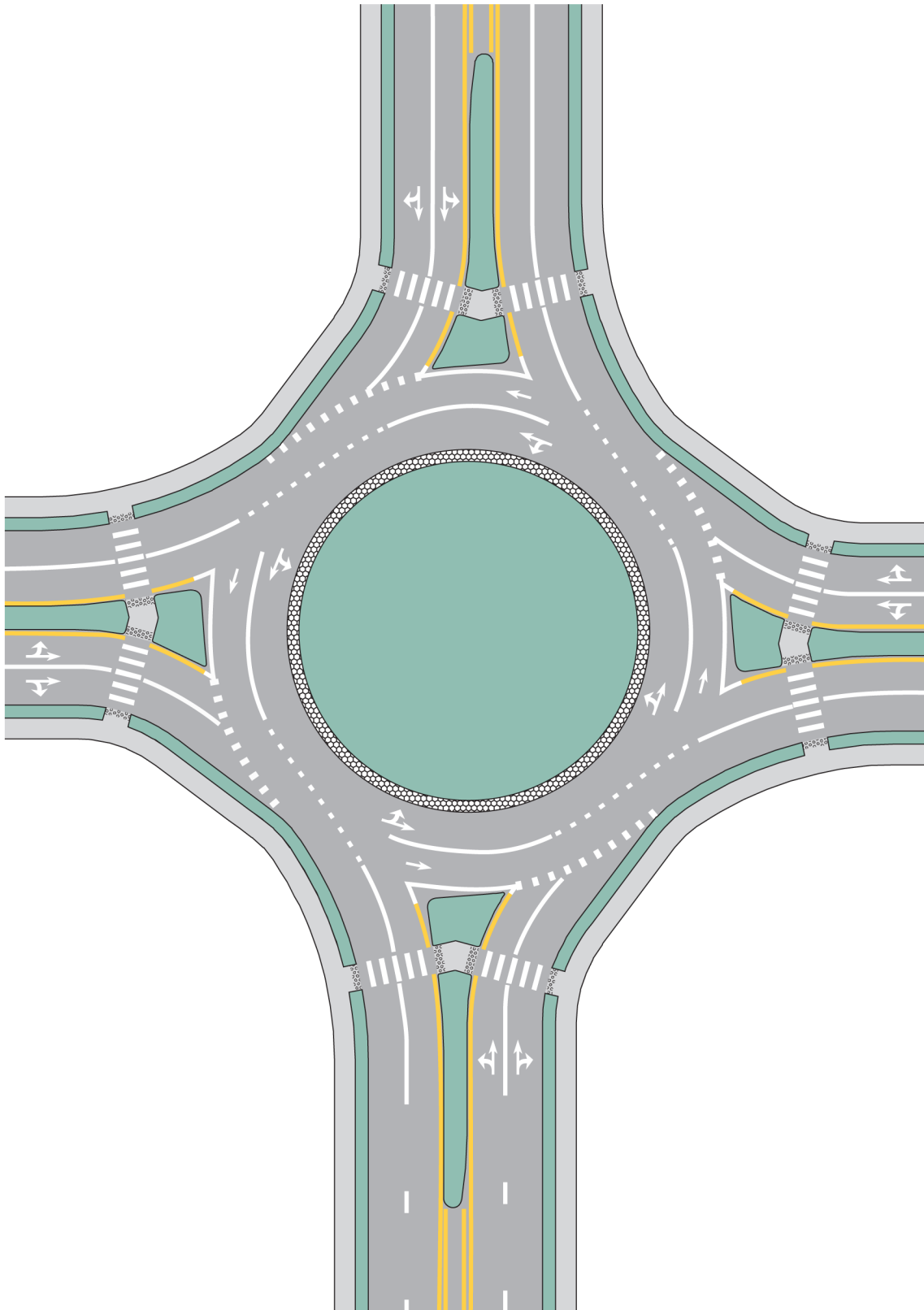
**Figure 3C-4. Example of Markings for a Two-Lane Roundabout with One- and Two-Lane Approaches (Sheet 2 of 2) (Delaware Revision)**



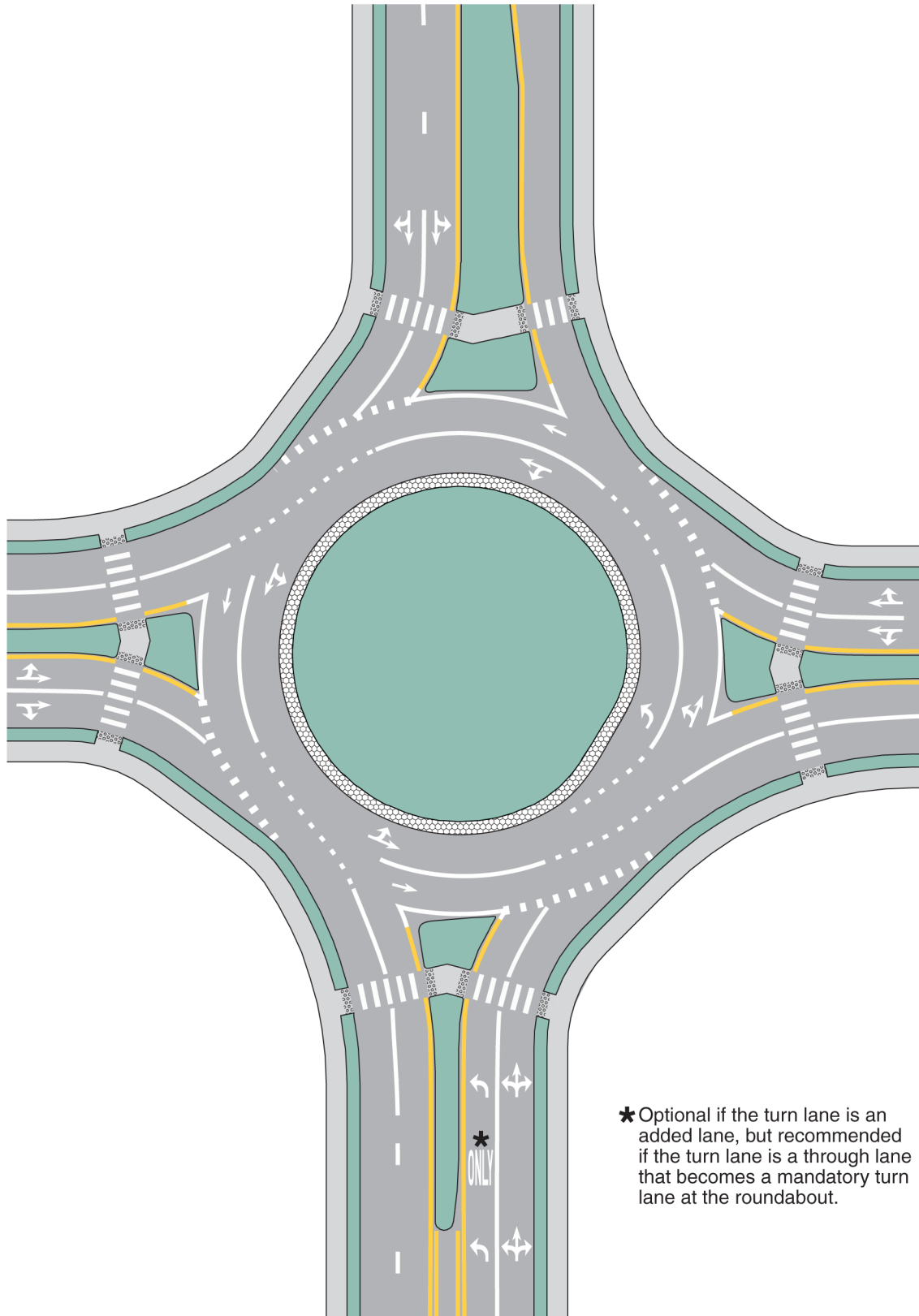
**Figure 3C-5. Example of Markings for a Two-Lane Roundabout with One-Lane Exits**



**Figure 3C-6. Example of Markings for a Two-Lane Roundabout with Two-Lane Exits**



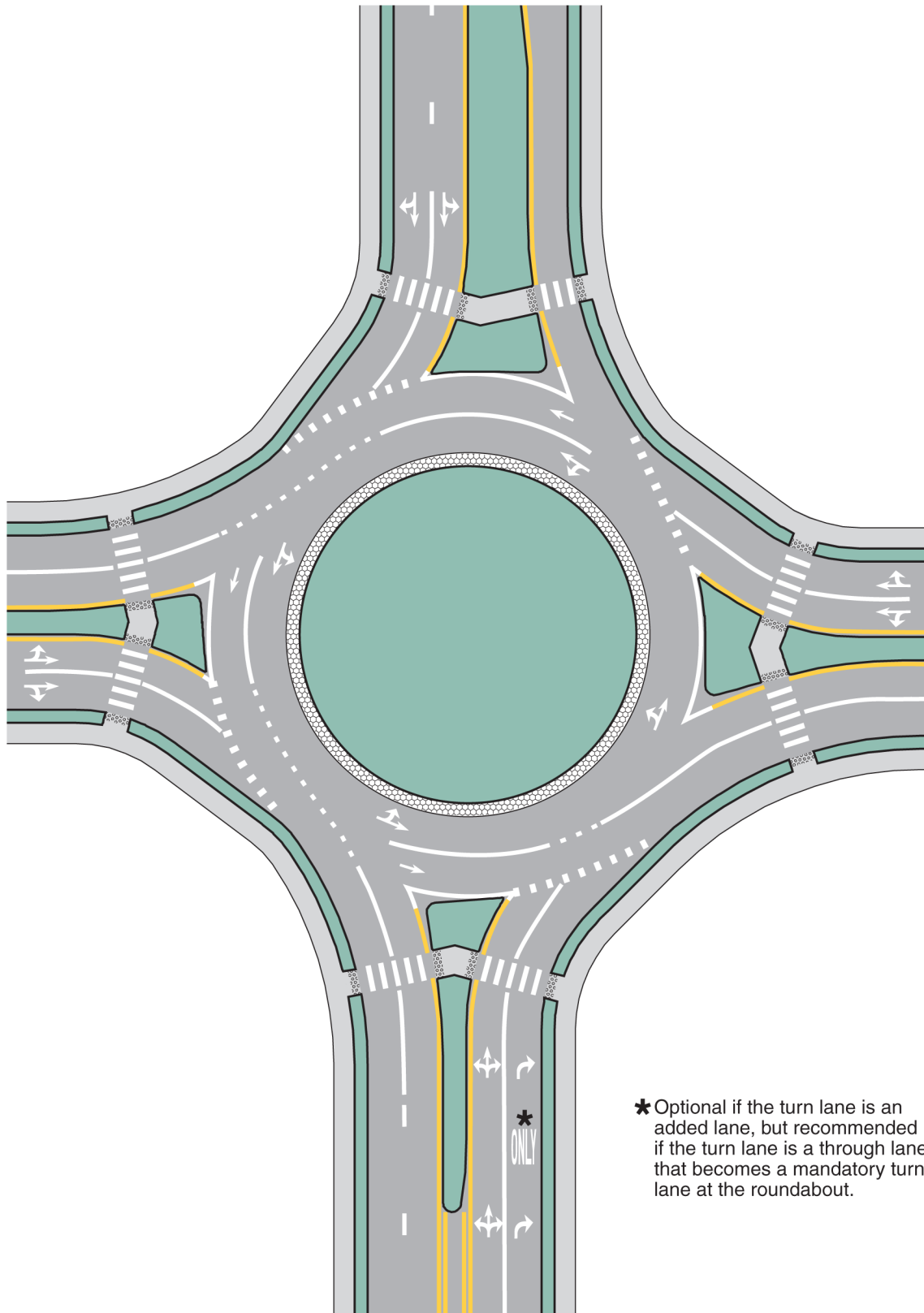
**Figure 3C-7. Example of Markings for a Two-Lane Roundabout with a Double Left Turn**



\* Optional if the turn lane is an added lane, but recommended if the turn lane is a through lane that becomes a mandatory turn lane at the roundabout.

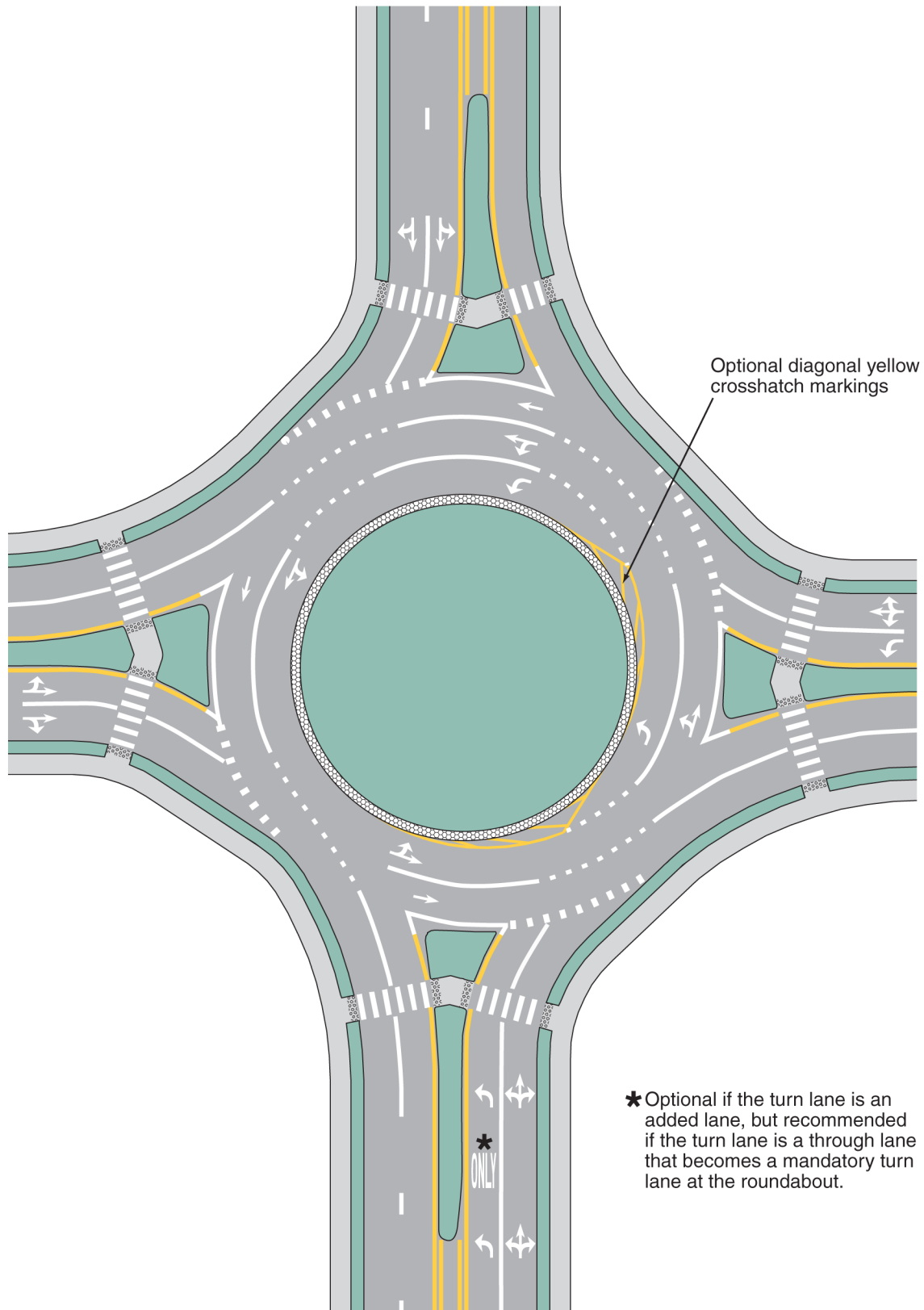


**Figure 3C-8. Example of Markings for a Two-Lane Roundabout with a Double Right Turn**

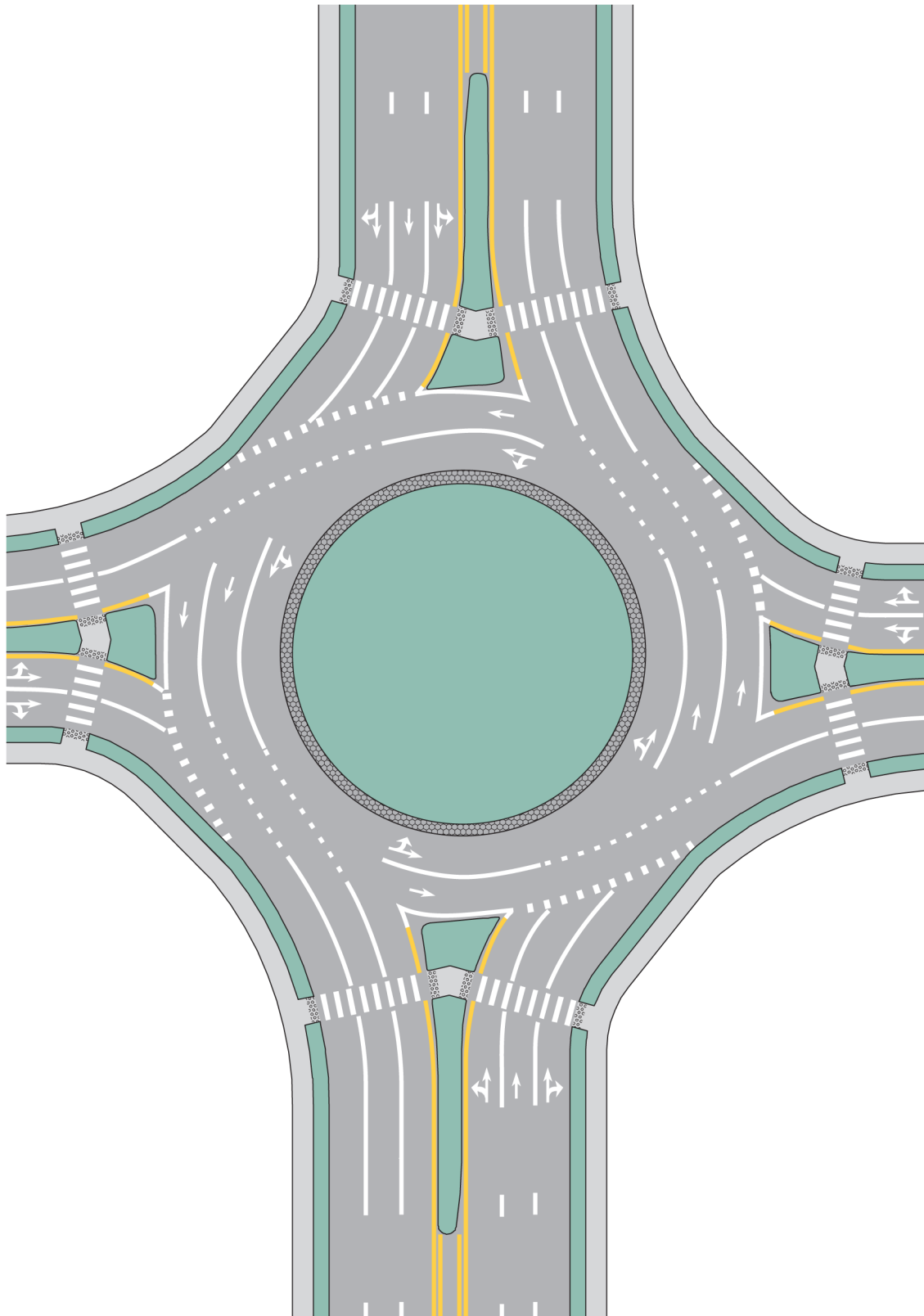


\* Optional if the turn lane is an added lane, but recommended if the turn lane is a through lane that becomes a mandatory turn lane at the roundabout.

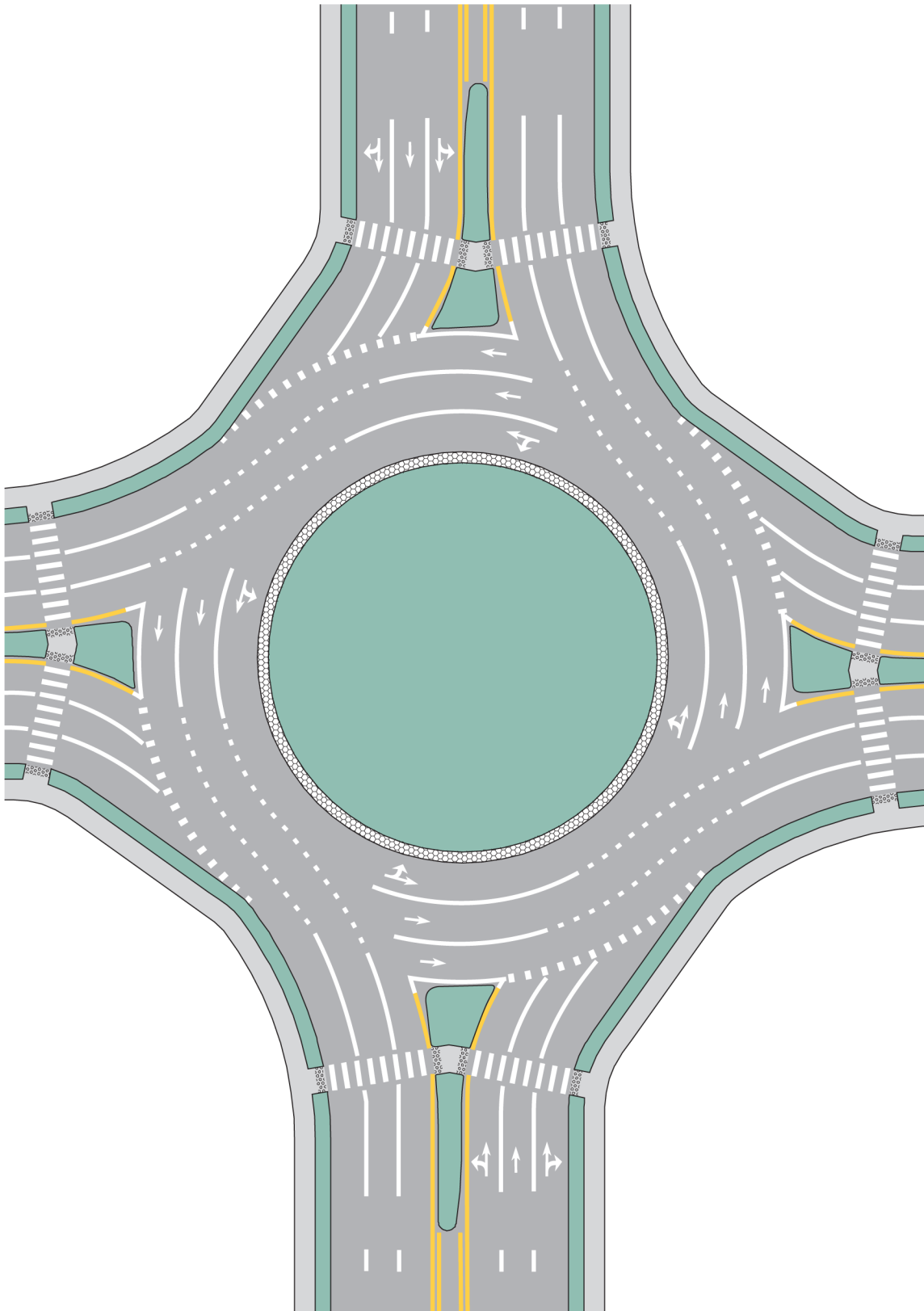
**Figure 3C-9. Example of Markings for a Two-Lane Roundabout with Consecutive Double Left Turns**



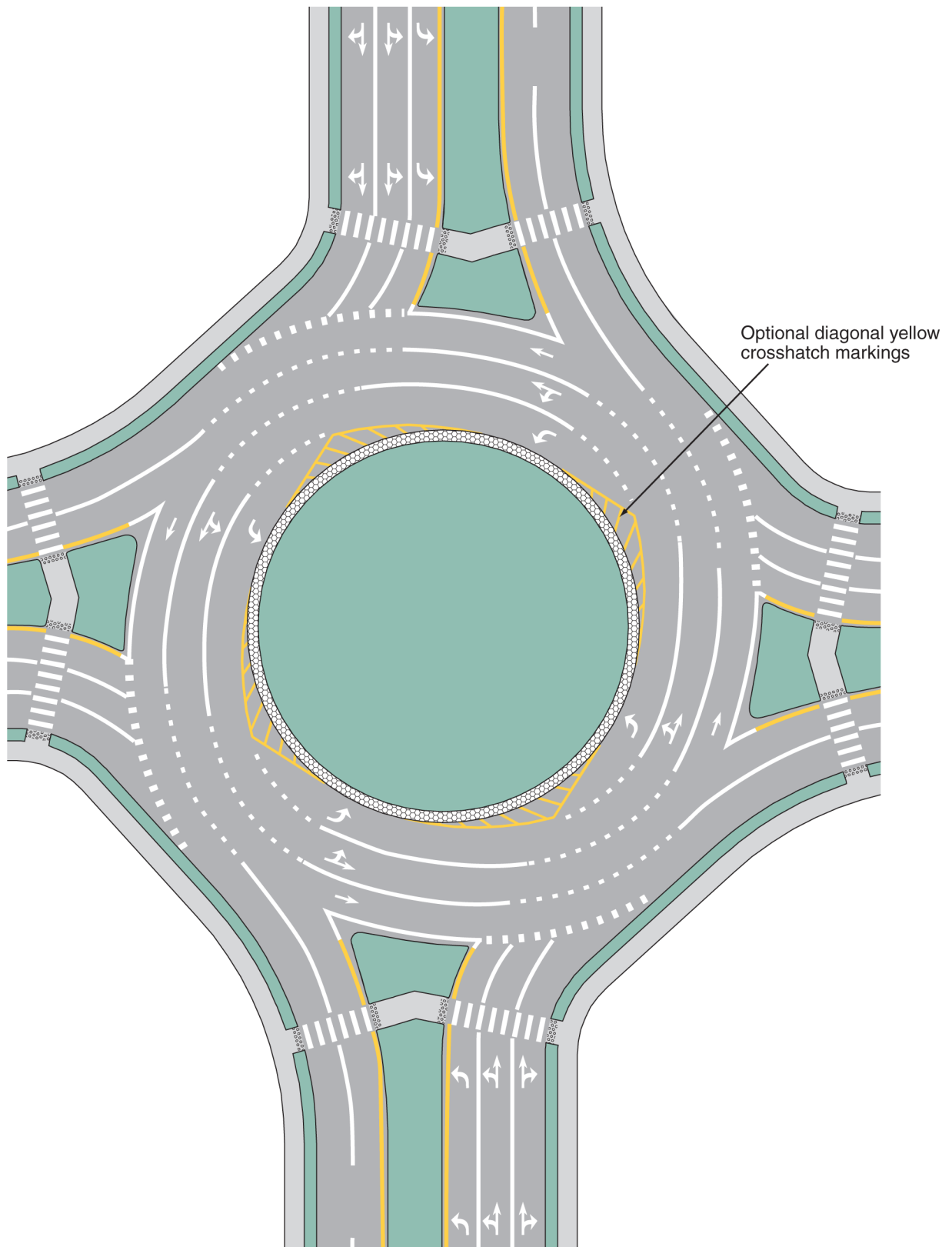
**Figure 3C-10. Example of Markings for a Three-Lane Roundabout with Two- and Three-Lane Approaches**



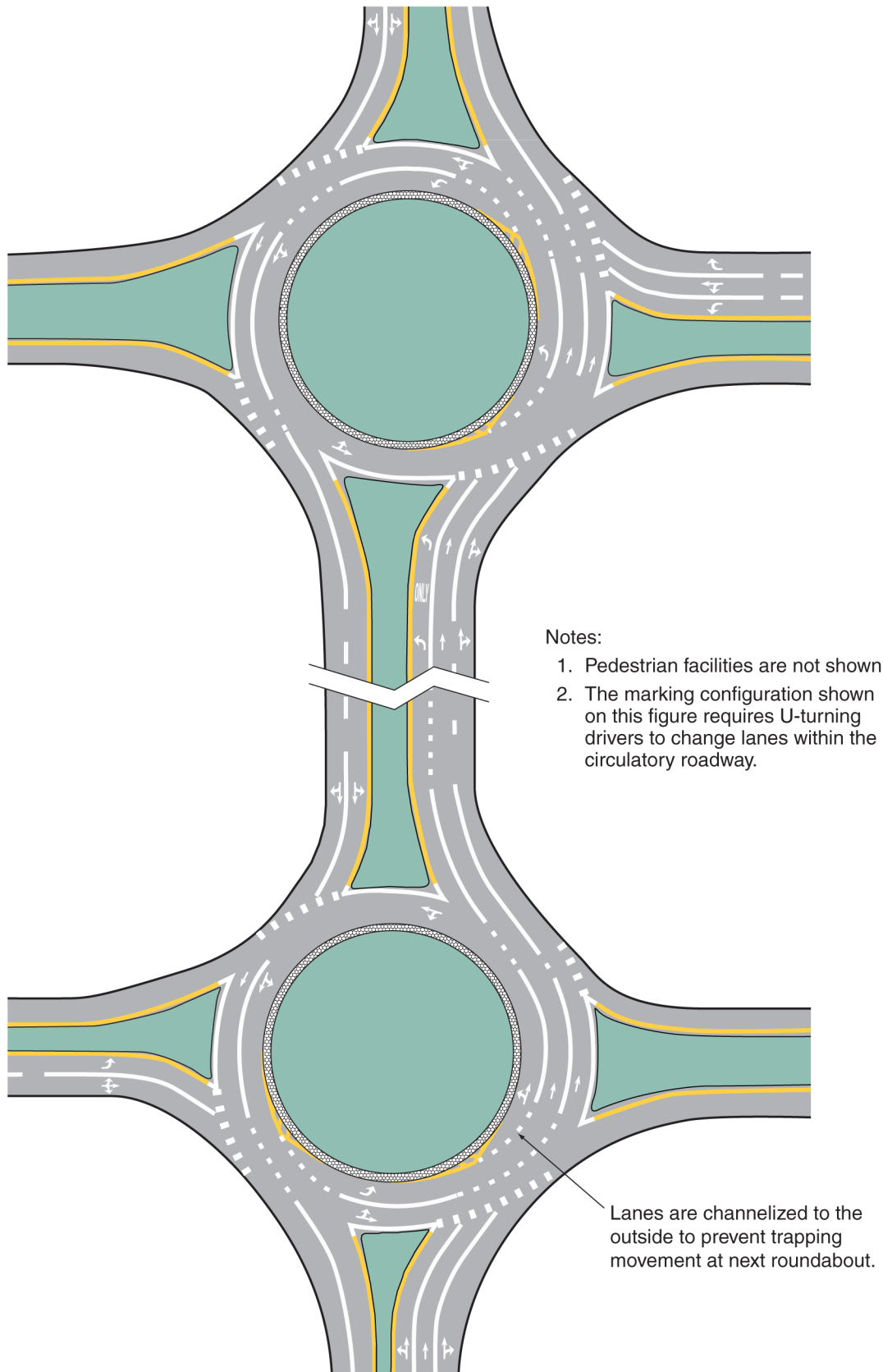
**Figure 3C-11. Example of Markings for a Three-Lane Roundabout with Three-Lane Approaches**



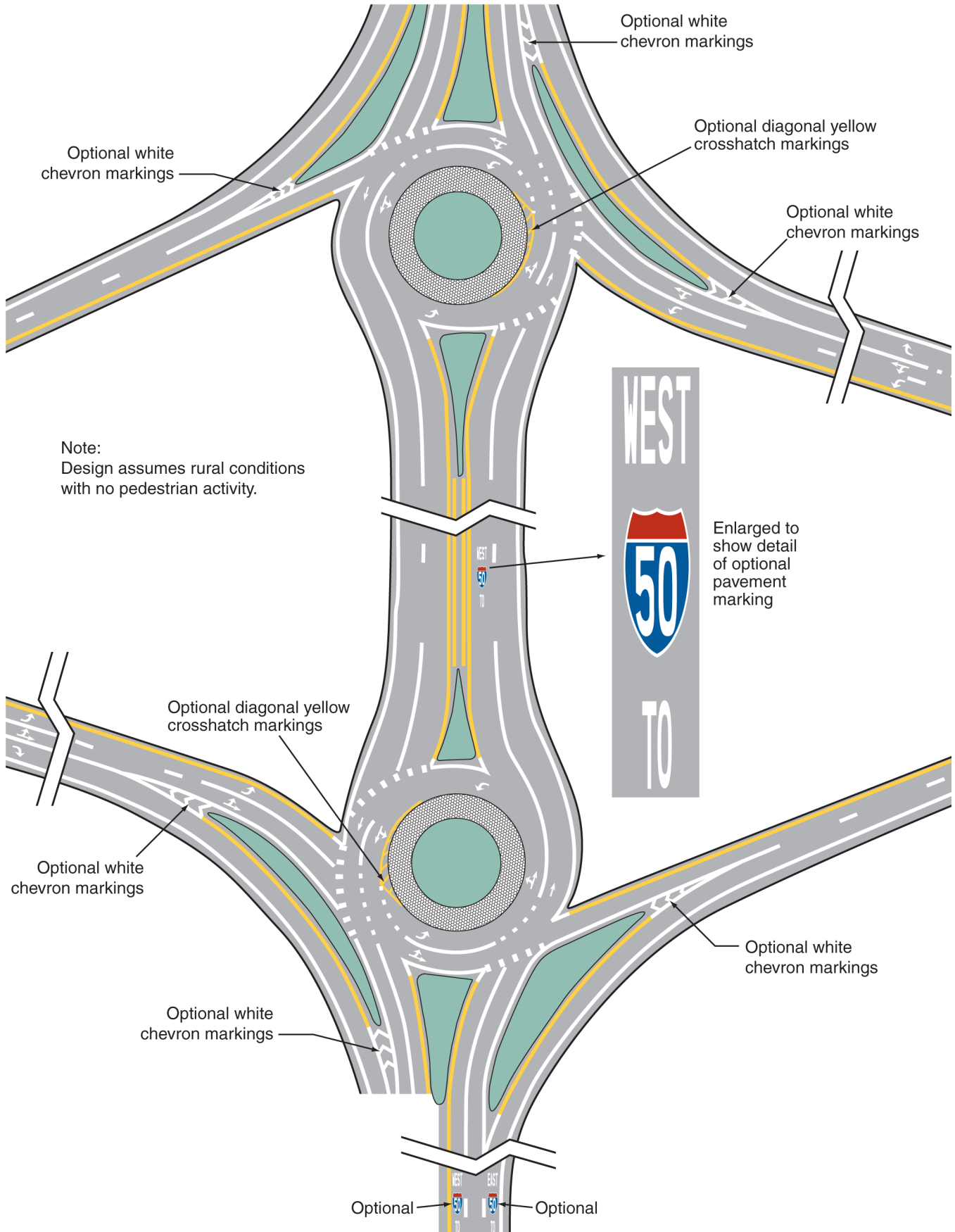
**Figure 3C-12. Example of Markings for a Three-Lane Roundabout with Two-Lane Exits**



**Figure 3C-13. Example of Markings for Two Linked Roundabouts**



**Figure 3C-14. Example of Markings for a Diamond Interchange with Two Circular-Shaped Roundabout Ramp Terminals**



(This Page Left Intentionally Blank)



## CHAPTER 3D. MARKINGS FOR PREFERENTIAL LANES

### Section 3D.01 Preferential Lane Word and Symbol Markings

#### Support:

01 Preferential lanes are established for one or more of a wide variety of special uses, including, but not limited to, high-occupancy vehicle (HOV) lanes, ETC lanes, high-occupancy toll (HOT) lanes, bicycle lanes, bus only lanes, taxi only lanes, and light rail transit only lanes.

#### Standard:

- 02 **When a lane is assigned full or part time to a particular class or classes of vehicles, the preferential lane word and symbol markings described in this Section and the preferential lane longitudinal markings described in Section 3D.02 shall be used.**
- 03 **All longitudinal pavement markings, as well as word and symbol pavement markings, associated with a preferential lane shall end where the Preferential Lane Ends (R3-12a or R3-12c) sign (see Section 2G.07) designating the downstream end of the preferential only lane restriction is installed.**
- 04 **Static or changeable message regulatory signs (see Sections 2G.03 to 2G.07) shall be used with preferential lane word or symbol markings.**
- 05 **All preferential lane word and symbol markings shall be white and shall be positioned laterally in the center of the preferential lane.**
- 06 **Where a preferential lane use exists contiguous to a general-purpose lane or is separated from a general-purpose lane by a flush buffered space that can be traversed by motor vehicles, the preferential lane shall be marked with one or more of the following symbol or word markings for the preferential lane use specified:**
- A. **HOV lane**—the preferential lane-use marking for high-occupancy vehicle lanes shall consist of white lines formed in a diamond shape symbol or the word message HOV. The diamond shall be at least 2.5 feet wide and 12 feet in length. The lines shall be at least 6 inches in width.
  - B. **HOT lane or ETC Account-Only lane**—except as provided in Paragraph 8, the preferential lane-use marking for a HOT lane or an ETC Account-Only lane shall consist of a word marking using the name of the ETC payment system required for use of the lane, such as E-Z PASS ONLY.
  - C. **Bicycle lane**—the preferential lane-use marking for a bicycle lane shall consist of a bicycle symbol or the word marking BIKE LANE (see Chapter 9C and Figures 9C-1 and 9C-3 through 9C-6).
  - D. **Bus only lane**—the preferential lane-use marking for a bus only lane shall consist of the word marking BUS ONLY.
  - E. **Taxi only lane**—the preferential lane-use marking for a taxi only lane shall consist of the word marking TAXI ONLY.
  - F. **Light rail transit lane**—the preferential lane-use marking for a light rail transit lane shall consist of the word marking LRT ONLY.
  - G. **Other type of preferential lane**—the preferential lane-use markings shall consist of a word marking appropriate to the restriction.
- 07 **If two or more preferential lane uses are permitted in a single lane, the symbol or word marking for each preferential lane use shall be installed.**

#### Option:

08 Preferential lane-use symbol or word markings may be omitted at toll plazas where physical conditions preclude the use of the markings (see Section 3E.01).

#### Guidance:

09 *The spacing of the markings should be based on engineering judgment that considers the prevailing speed, block lengths, distance from intersections, and other factors that affect clear communication to the road user.*

#### Support:

10 Markings spaced as close as 80 feet apart might be appropriate on city streets, while markings spaced as far as 1,000 feet apart might be appropriate for freeways.

*Guidance:*

11 *In addition to a regular spacing interval, the preferential lane marking should be placed at strategic locations such as major decision points, direct exit ramp departures from the preferential lane, and along access openings to and from adjacent general-purpose lanes. At decision points, the preferential lane marking should be placed on all applicable lanes and should be visible to approaching traffic for all available departures. At direct exits from preferential lanes where extra emphasis is needed, the use of word markings (such as “EXIT” or “EXIT ONLY”) in the deceleration lane for the direct exit and/or on the direct exit ramp itself just beyond the exit gore should be considered.*

## Option:

12 A numeral indicating the vehicle occupancy requirements established for a high-occupancy vehicle lane may be included in sequence after the diamond symbol or HOV word message.

*Guidance:*

13 *Engineering judgment should determine the need for supplemental devices such as tubular markers, traffic cones, or other channelizing devices (see Chapter 3H).*

**Section 3D.02 Preferential Lane Longitudinal Markings for Motor Vehicles**

## Support:

01 Preferential lanes can take many forms depending on the level of usage and the design of the facility. They might be barrier-separated or buffer-separated from the adjacent general-purpose lanes, or they might be contiguous with the adjacent general-purpose lanes. Barrier-separated preferential lanes might be operated in a constant direction or be operated as reversible lanes. Some reversible preferential lanes on a divided highway might be operated counter-flow to the direction of traffic on the immediately adjacent general-purpose lanes. See Section 1A.13 for definitions of terms.

02 Preferential lanes might be operated full-time (24 hours per day on all days), for extended periods of the day, part-time (restricted usage during specific hours on specified days), or on a variable basis (such as a strategy for a managed lane).

**Standard:**

03 **Longitudinal pavement markings for preferential lanes shall be as follows (these same requirements are presented in tabular form in Table 3D-1):**

- A. **Barrier-separated, non-reversible preferential lane—the longitudinal pavement markings for preferential lanes that are physically separated from the other travel lanes by a barrier or median shall consist of a normal solid single yellow line at the left-hand edge of the travel lane(s), and a normal solid single white line at the right-hand edge of the travel lane(s) (see Drawing A in Figure 3D-1).**
- B. **Barrier-separated, reversible preferential lane—the longitudinal pavement markings for reversible preferential lanes that are physically separated from the other travel lanes by a barrier or median shall consist of a normal solid single white line at both edges of the travel lane(s) (see Drawing B in Figure 3D-1).**
- C. **Buffer-separated (left-hand side) preferential lane—the longitudinal pavement markings for a full-time or part-time preferential lane on the left-hand side of and separated from the other travel lanes by a neutral buffer space shall consist of a normal solid single yellow line at the left-hand edge of the preferential travel lane(s) and one of the following at the right-hand edge of the preferential travel lane(s):**
  - 1. **A wide solid double white line along both edges of the buffer space where crossing the buffer space is prohibited (see Drawing A in Figure 3D-2).**
  - 2. **A wide solid single white line along both edges of the buffer space where crossing the buffer space is discouraged (see Drawing B in Figure 3D-2).**
  - 3. **A wide broken single white line along both edges of the buffer space, or a wide broken single white lane line within the allocated buffer space (resulting in wider lanes), where crossing the buffer space is permitted (see Drawing C in Figure 3D-2).**

**Table 3D-1. Standard Edge Line and Lane Line Markings for Preferential Lanes**

Type of Preferential Lane	Left-Hand Edge Line	Right-Hand Edge Line
Barrier-Separated, Non-Reversible	A normal solid single yellow line	A normal solid single white line (see Drawing A of Figure 3D-1)
Barrier-Separated, Reversible	A normal solid single white line	A normal solid single white line (see Drawing B of Figure 3D-1)
Buffer-Separated, Left-Hand Side	A normal solid single yellow line	<p>A wide solid double white line along both edges of the buffer space where crossing is prohibited (see Drawing A of Figure 3D-2)</p> <p>A wide solid single white line along both edges of the buffer space where crossing is discouraged (see Drawing B of Figure 3D-2)</p> <p>A wide broken single white line along both edges of the buffer space, or a wide broken single white line within the buffer space (resulting in wider lanes), where crossing is permitted (see Drawing C of Figure 3D-2)</p>
Buffer-Separated, Right-Hand Side	<p>A wide solid double white line along both edges of the buffer space where crossing is prohibited (see Drawing D of Figure 3D-2)</p> <p>A wide solid single white line along both edges of the buffer space where crossing is discouraged (see Drawing D of Figure 3D-2)</p> <p>A wide broken single white line along both edges of the buffer space, or a wide broken single white line within the buffer space (resulting in wider lanes), where crossing is permitted (see Drawing D of Figure 3D-2)</p> <p>A wide dotted single white line within the buffer space (resulting in wider lanes) where crossing is permitted for any vehicle to perform a right-turn maneuver (see Drawing D of Figure 3D-2)</p>	A normal solid single white line (if warranted)
Contiguous, Left-Hand Side	A normal solid single yellow line	<p>A wide solid double white line where crossing is prohibited (see Drawing A of Figure 3D-3)</p> <p>A wide solid single white line where crossing is discouraged (see Drawing B of Figure 3D-3)</p> <p>A wide broken single white line where crossing is permitted (see Drawing C of Figure 3D-3)</p>
Contiguous, Right-Hand Side	<p>A wide solid double white line where crossing is prohibited (see Drawing D of Figure 3D-3)</p> <p>A wide solid single white line where crossing is discouraged (see Drawing D of Figure 3D-3)</p> <p>A wide broken single white line where crossing is permitted (see Drawing D of Figure 3D-3)</p> <p>A wide dotted single white line where crossing is permitted for any vehicle to perform a right-turn maneuver (see Drawing D of Figure 3D-3)</p>	A normal solid single white line

- Notes: 1. If there are two or more preferential lanes, the lane lines between the preferential lanes shall be normal broken white lines.  
 2. The standard lane markings listed in this table are provided in a tabular format for reference.  
 3. This information is also described in Paragraph 3 of Section 3D.02.

**D. Buffer-separated (right-hand side) preferential lane**—the longitudinal pavement markings for a full-time or part-time preferential lane on the right-hand side of and separated from the other travel lanes by a neutral buffer space shall consist of a normal solid single white line at the right-hand edge of the preferential travel lane(s) if warranted (see Section 3B.07) and one of the following at the left-hand edge of the preferential travel lane(s) (see Drawing D in Figure 3D-2):

1. A wide solid double white line along both edges of the buffer space where crossing the buffer space is prohibited.
2. A wide solid single white line along both edges of the buffer space where crossing of the buffer space is discouraged.
3. A wide broken single white line along both edges of the buffer space, or a wide broken single white line within the allocated buffer space (resulting in wider lanes), where crossing the buffer space is permitted.
4. A wide dotted single white lane line within the allocated buffer space (resulting in wider lanes) where crossing the buffer space is permitted for any vehicle to perform a right-turn maneuver.

**E. Contiguous (left-hand side) preferential lane**—the longitudinal pavement markings for a full-time or part-time preferential lane on the left-hand side of and contiguous to the other travel lanes shall consist of a normal solid single yellow line at the left-hand edge of the preferential travel lane(s) and one of the following at the right-hand edge of the preferential travel lane(s):

1. A wide solid double white lane line where crossing is prohibited (see Drawing A in Figure 3D-3).
2. A wide solid single white lane line where crossing is discouraged (see Drawing B in Figure 3D-3).
3. A wide broken single white lane line where crossing is permitted (see Drawing C in Figure 3D-3).

**F. Contiguous (right-hand side) preferential lane**—the longitudinal pavement markings for a full-time or part-time preferential lane on the right-hand side of and contiguous to the other travel lanes shall consist of a normal solid single white line at the right-hand edge of the preferential travel lane(s) if warranted (see Section 3B.07) and one of the following at the left-hand edge of the preferential travel lane(s) (see Drawing D in Figure 3D-3):

1. A wide solid double white lane line where crossing is prohibited.
2. A wide solid single white lane line where crossing is discouraged.
3. A wide broken single white lane line where crossing is permitted.
4. A wide dotted single white lane line where crossing is permitted for any vehicle to perform a right-turn maneuver.

*Guidance:*

04 *Where preferential lanes and other travel lanes are separated by a buffer space wider than 4 feet and crossing the buffer space is prohibited, chevron markings (see Section 3B.24) should be placed in the buffer area (see Drawing A in Figure 3D-2). The chevron spacing should be 100 feet or greater.*

*Option:*

05 *If a full-time or part-time contiguous preferential lane is separated from the other travel lanes by a wide broken single white line (see Drawing C in Figure 3D-3), the spacing or skip pattern of the line may be reduced and the width of the line may be increased.*

**Standard:**

06 **If there are two or more preferential lanes for traffic moving in the same direction, the lane lines between the preferential lanes shall be normal broken white lines.**

07 **Preferential lanes for motor vehicles shall also be marked with the appropriate word or symbol pavement markings in accordance with Section 3D.01 and shall have appropriate regulatory signs in accordance with Sections 2G.03 through 2G.07.**

*Guidance:*

08 *At direct exits from a preferential lane, dotted white line markings should be used to separate the tapered or parallel deceleration lane for the direct exit (including the taper) from the adjacent continuing preferential through lane, to reduce the chance of unintended exit maneuvers.*

**Standard:**

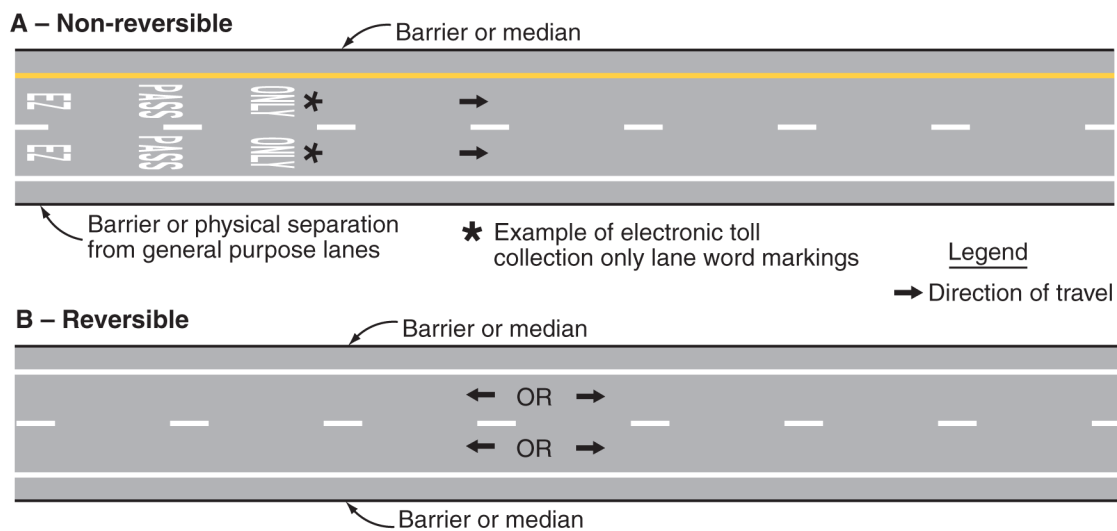
09 On a divided highway, a part-time counter-flow preferential lane that is contiguous to the travel lanes in the opposing direction shall be separated from the opposing direction lanes by the standard reversible lane longitudinal marking, a normal width broken double yellow line (see Section 3B.03 and Drawing A of Figure 3D-4). If a buffer space is provided between the part-time counter-flow preferential lane and the opposing direction lanes, a normal width broken double yellow line shall be placed along both edges of the buffer space (see Drawing B of Figure 3D-4). Signs (see Section 2B.26), lane-use control signals (see Chapter 4M), or both shall be used to supplement the reversible lane markings.

10 On a divided highway, a full-time counter-flow preferential lane that is contiguous to the travel lanes in the opposing direction shall be separated from the opposing direction lanes by a solid double yellow center line marking (see Drawing C of Figure 3D-4). If a buffer space is provided between the full-time counter-flow preferential lane and the opposing direction lanes, a normal width solid double yellow line shall be placed along both edges of the buffer space (see Drawing D of Figure 3D-4).

**Option:**

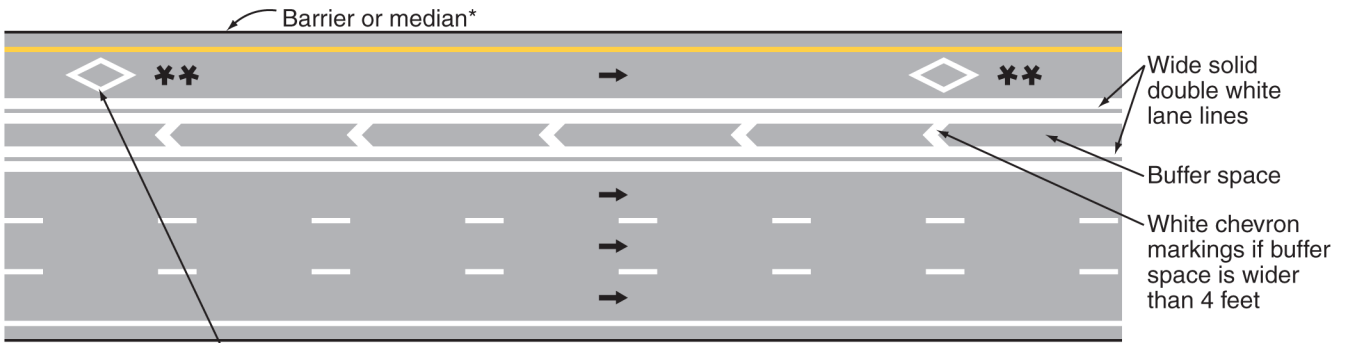
11 Cones, tubular markers, or other channelizing devices (see Chapter 3H) may also be used to separate the opposing lanes when a counter-flow preferential lane operation is in effect.

**Figure 3D-1. Markings for Barrier-Separated Preferential Lanes**



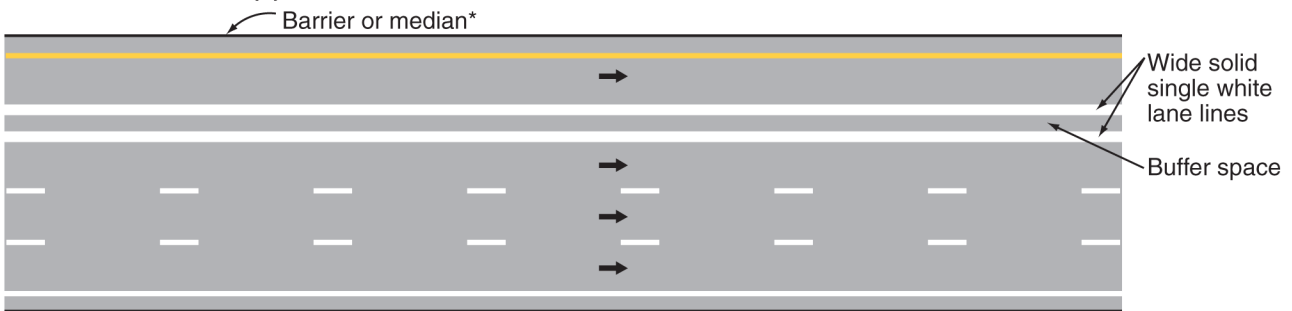
**Figure 3D-2. Markings for Buffer-Separated Preferential Lanes (Sheet 1 of 2)**

**A – Full-time preferential lane(s) where enter/exit movements are PROHIBITED**



Space at 1/4-mile intervals or as determined by engineering judgment (see Section 3D.01)

**B – Preferential lane(s) where enter/exit movements are DISCOURAGED**



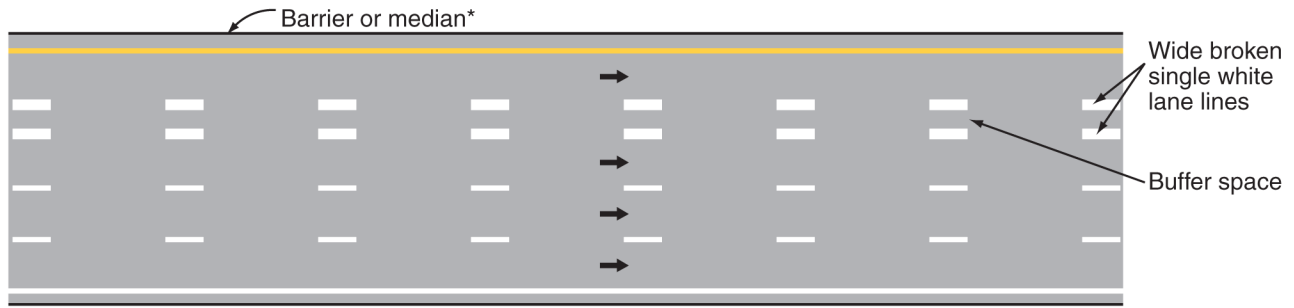
Legend

➔ Direction of travel

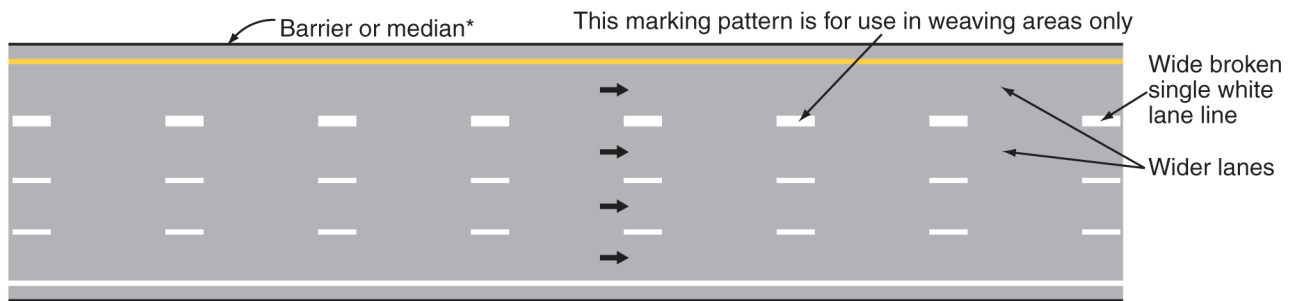
- \* If no barrier or median is present and the left-hand side of the lane is the center line of a two-way roadway, use a double yellow center line
- \*\* Example of HOV only lane symbol markings

**Figure 3D-2. Markings for Buffer-Separated Preferential Lanes (Sheet 2 of 2)**

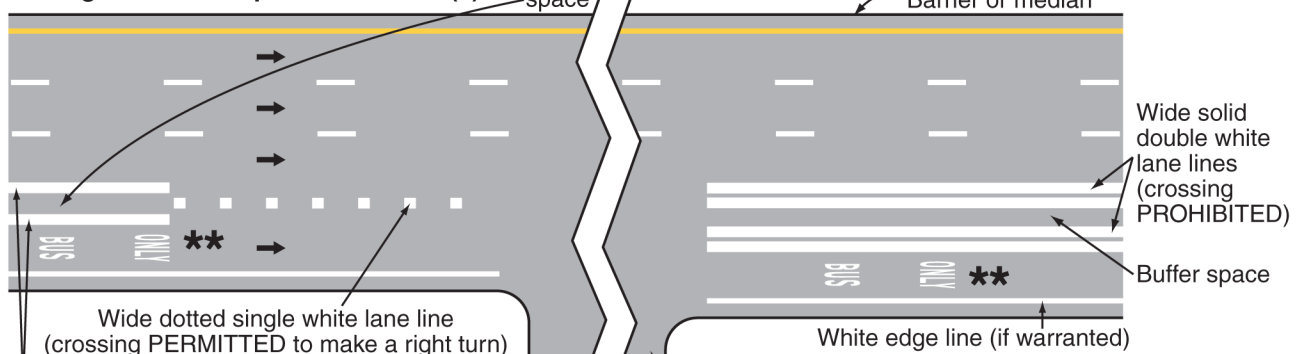
**C – Preferential lane(s) where enter/exit movements are PERMITTED**



**OR**



**D – Right-hand side preferential lane(s)**

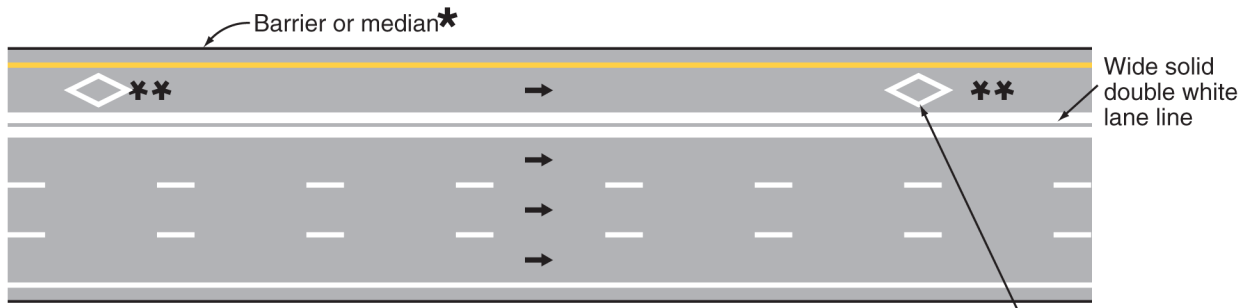


**Legend**  
 → Direction of travel

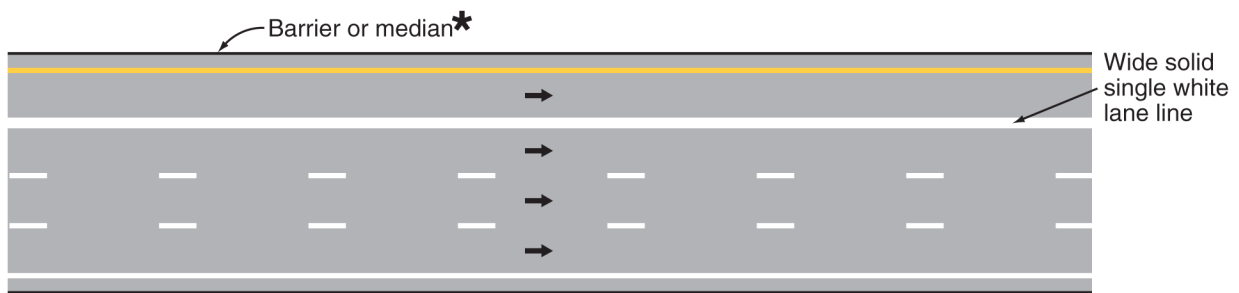
- \* If no barrier or median is present and the left-hand side of the lane is the center line of a two-way roadway, use a double yellow center line
- \*\* Example of bus lane word markings

**Figure 3D-3. Markings for Contiguous Preferential Lanes**

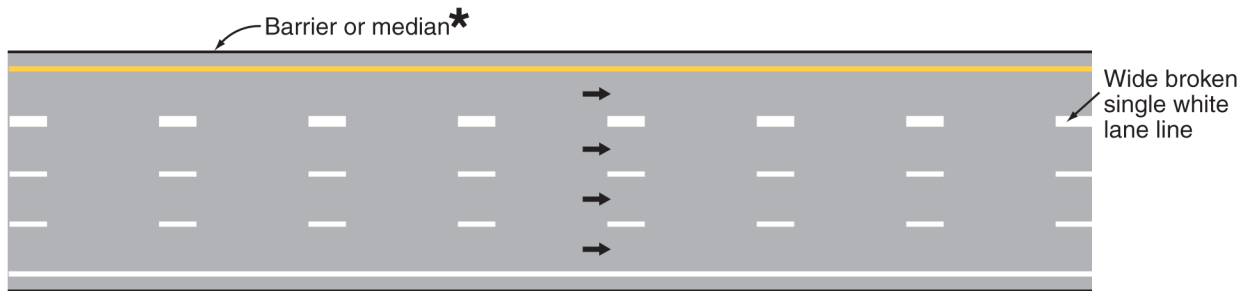
**A – Full-time preferential lane(s) where enter/exit movements are PROHIBITED**



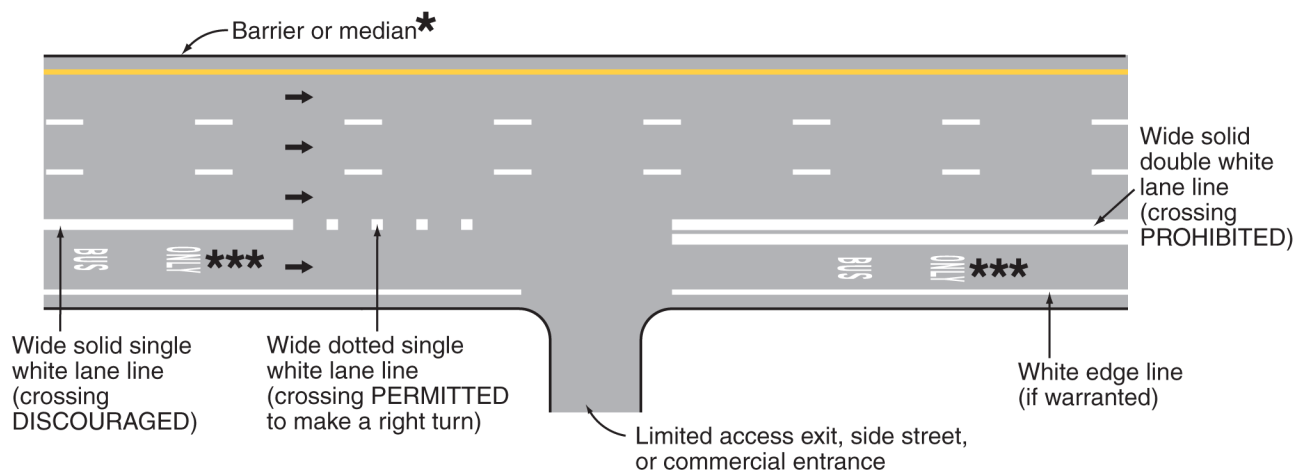
**B – Preferential lane(s) where enter/exit movements are DISCOURAGED** Space at 1/4-mile intervals



**C – Preferential lane(s) where enter/exit movements are PERMITTED**



**D – Right-hand side preferential lane(s)**



Legend

➔ Direction of travel

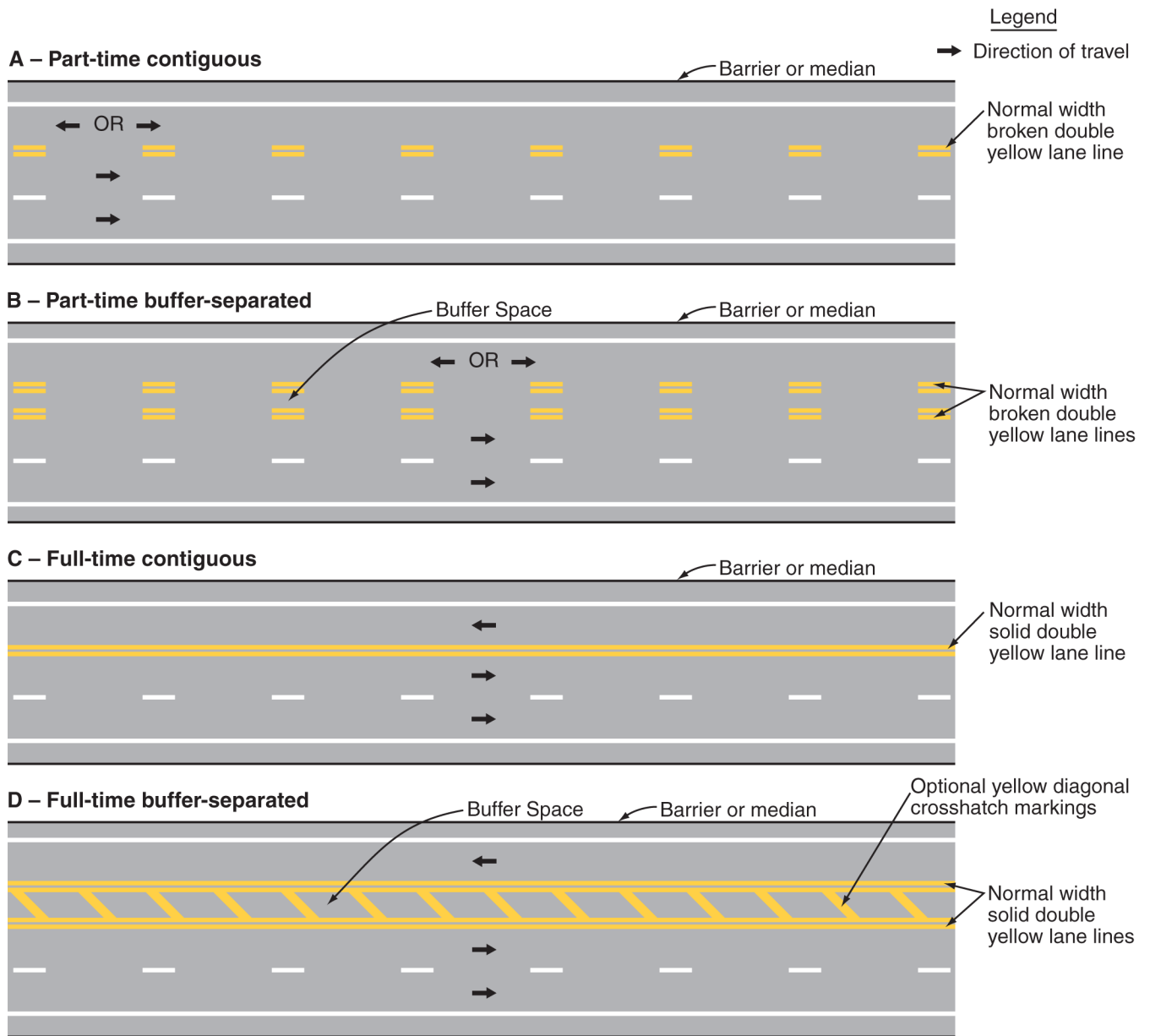
\* If no barrier or median is present and the left-hand side of the lane is the center line of a two-way roadway, use a double yellow center line

\*\* Example of HOV only lane symbol markings

\*\*\* Example of bus lane word markings



Figure 3D-4. Markings for Counter-Flow Preferential Lanes on Divided Highways



(This Page Left Intentionally Blank)

## CHAPTER 3E. MARKINGS FOR TOLL PLAZAS

### Section 3E.01 Markings for Toll Plazas

#### Support:

01 At toll plazas, pavement markings help road users identify the proper lane(s) to use for the type of toll payment they plan to use, to channelize movements into the various lanes, and to delineate obstructions in the roadway.

#### Standard:

02 **When a lane on the approach to a toll plaza is restricted to use only by vehicles with registered ETC accounts, the ETC Account-Only lane word markings described in Section 3D.01 and the preferential lane longitudinal markings described in Section 3D.02 shall be used. When one or more ORT lanes that are restricted to use only by vehicles with registered ETC accounts bypass a mainline toll plaza on a separate alignment, these word markings and longitudinal markings shall be used on the approach to the point where the ORT lanes diverge from the lanes destined for the mainline toll plaza.**

#### Option:

03 Preferential lane-use symbol or word markings may be omitted at toll plazas where physical conditions preclude the use of the markings.

#### Guidance:

04 *If an ORT lane that is immediately adjacent to a mainline toll plaza is not separated from adjacent cash payment toll plaza lanes by a curb or barrier, then channelizing devices (see Section 3H.01), and/or longitudinal pavement markings that discourage or prohibit lane changing should be used to separate the ORT lane from the adjacent cash payment lane. This separation should begin on the approach to the mainline toll plaza at approximately the point where the vehicle speeds in the adjacent cash lanes drop below 30 mph during off-peak periods and should extend downstream beyond the toll plaza approximately to the point where the vehicles departing the toll plaza in the adjacent cash lanes have accelerated to 30 mph.*

#### Option:

05 For a toll plaza approach lane that is restricted to use only by vehicles with registered ETC accounts, the solid white lane line or edge line on the right-hand side of the ETC Account-Only lane and the solid white lane line or solid yellow edge line on the left-hand side of the ETC Account-Only lane may be supplemented with purple solid longitudinal markings placed contiguous to the inside edges of the lines defining the lane.

#### Standard:

06 **If used, the purple solid longitudinal marking described in the previous paragraph shall be a minimum of 3 inches in width and a maximum width equal to the width of the line it supplements, and ETC Account-Only preferential lane word markings (see Section 3D.01) shall be installed within the lane.**

07 **Toll booths and the islands on which they are located are considered to be obstructions in the roadway and they shall be provided with markings that comply with the provisions of Section 3B.10 and Chapter 3G.**

#### Option:

08 Longitudinal pavement markings may be omitted alongside toll booth islands between the approach markings and any departure markings.

(This Page Left Intentionally Blank)

## CHAPTER 3F. DELINEATORS

### Section 3F.01 Delineators

#### Support:

01 Delineators are particularly beneficial at locations where the alignment might be confusing or unexpected, such as at lane-reduction transitions and curves. Delineators are effective guidance devices at night and during adverse weather. An important advantage of delineators in certain locations is that they remain visible when the roadway is wet or snow covered.

02 Delineators are considered guidance devices rather than warning devices.

#### Option:

03 Delineators may be used on long continuous sections of highway or through short stretches where there are changes in horizontal alignment.

### Section 3F.02 Delineator Design

#### Standard:

01 **Delineators shall consist of retroreflective devices that are capable of clearly retroreflecting light under normal atmospheric conditions from a distance of 1,000 feet when illuminated by the high beams of standard automobile lights.**

02 **Retroreflective elements for delineators shall have a minimum dimension of 3 inches.**

#### Support:

03 Within a series of delineators along a roadway, delineators for a given direction of travel at a specific location are referred to as single delineators if they have one retroreflective element for that direction, double delineators if they have two identical retroreflective elements for that direction mounted together, or vertically elongated delineators if they have a single retroreflective element with an elongated vertical dimension to approximate the vertical dimension of two separate single delineators.

#### Option:

04 A vertically elongated delineator of appropriate size may be used in place of a double delineator.

### Section 3F.03 Delineator Application

#### Standard:

01 **The color of delineators shall comply with the color of edge lines stipulated in Section 3B.06.**

02 **A series of single delineators shall be provided on the right-hand side of freeways and expressways and on at least one side of interchange ramps, except when either Condition A or Condition B is met, as follows:**

- A. On tangent sections of freeways and expressways when both of the following conditions are met:**
  - 1. Raised pavement markers are used continuously on lane lines throughout all curves and on all tangents to supplement pavement markings, and**
  - 2. Roadside delineators are used to lead into all curves.**
- B. On sections of roadways where continuous lighting is in operation between interchanges.**

#### Option:

03 Delineators may be provided on other classes of roads. A series of single delineators may be provided on the left-hand side of roadways.

#### Standard:

04 **Delineators on the left-hand side of a two-way roadway shall be white (see Figure 3F-1).**

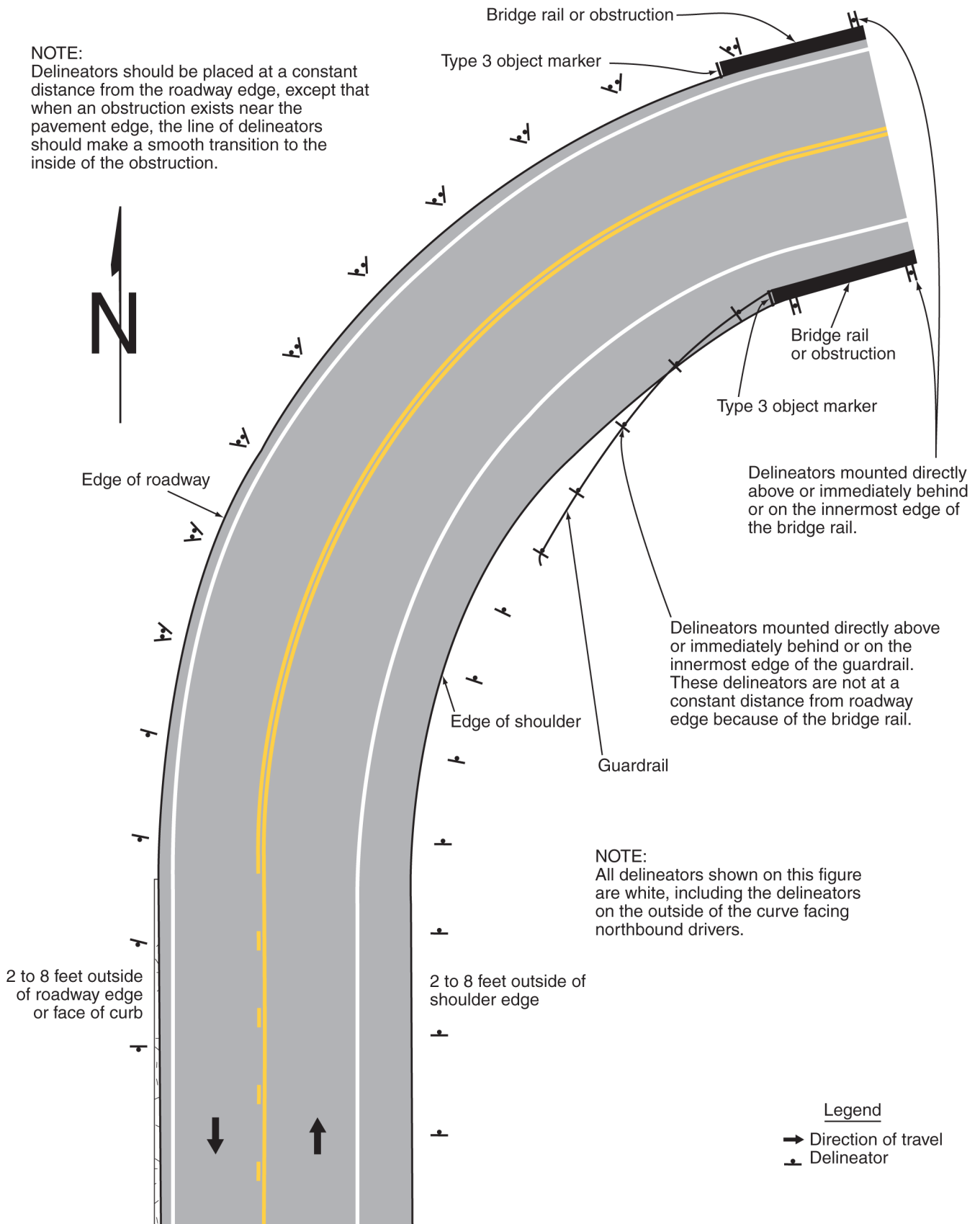
#### Guidance:

05 *A series of single delineators should be provided on the outside of curves on interchange ramps.*

06 *Where median crossovers are provided for official or emergency use on divided highways and where these crossovers are to be marked, a double yellow delineator should be placed on the left-hand side of the through roadway on the far side of the crossover for each roadway.*

**Figure 3F-1. Examples of Delineator Placement**

**NOTE:**  
Delineators should be placed at a constant distance from the roadway edge, except that when an obstruction exists near the pavement edge, the line of delineators should make a smooth transition to the inside of the obstruction.



Delineators mounted directly above or immediately behind or on the innermost edge of the bridge rail.

Delineators mounted directly above or immediately behind or on the innermost edge of the guardrail. These delineators are not at a constant distance from roadway edge because of the bridge rail.

**NOTE:**  
All delineators shown on this figure are white, including the delineators on the outside of the curve facing northbound drivers.

2 to 8 feet outside of roadway edge or face of curb

2 to 8 feet outside of shoulder edge

Legend

- Direction of travel
- Delineator

07 *Double or vertically elongated delineators should be installed at 100-foot intervals along acceleration and deceleration lanes.*

08 *(DE Revision) A series of delineators should be used in accordance with Paragraph 3 of Section 3F.04 wherever guardrail or other longitudinal barriers are present along a roadway or ramp.*

Option:

09 Red delineators may be used on the reverse side of any delineator where it would be viewed by a road user traveling in the wrong direction on that particular ramp or roadway.

10 Delineators of the appropriate color may be used to indicate a lane-reduction transition where either an outside or inside lane merges into an adjacent lane.

Guidance:

11 *When used for lane-reduction transitions, the delineators should be installed adjacent to the lane or lanes reduced for the full length of the transition and should be so placed and spaced to show the reduction (see Figure 3B-14).*

Support:

12 Delineators are not necessary for traffic moving in the direction of a wider pavement or on the side of the roadway where the alignment is not affected by the lane-reduction transition.

Guidance:

13 *On a highway with continuous delineation on either or both sides, delineators should be carried through transitions.*

Option:

14 On a highway with continuous delineation on either or both sides, the spacing between a series of delineators may be closer.

**Standard:**

15 **When used on a truck escape ramp, delineators shall be red.**

Guidance:

16 *Red delineators should be placed on both sides of truck escape ramps. The delineators should be spaced at 50-foot intervals for a distance sufficient to identify the ramp entrance. Delineator spacing beyond the ramp entrance should be adequate for guidance according to the length and design of the escape ramp.*

### **Section 3F.04 Delineator Placement and Spacing**

Guidance:

01 *Delineators should be mounted on suitable supports at a mounting height, measured vertically from the bottom of the lowest retroreflective device to the elevation of the near edge of the roadway, of approximately 4 feet.*

Option:

02 When mounted on the face of or on top of guardrails or other longitudinal barriers, delineators may be mounted at a lower elevation than the normal delineator height recommended in Paragraph 1.

02A *(DE Revision) In residential areas, delineators may be mounted at a height so that the top of the highest retroreflective device is less than 4 feet above the edge of the roadway.*

Guidance:

03 *Delineators should be placed 2 to 8 feet outside the outer edge of the shoulder, or if appropriate, in line with the roadside barrier that is 8 feet or less outside the outer edge of the shoulder.*

04 *Delineators should be placed at a constant distance from the edge of the roadway, except that where an obstruction intrudes into the space between the pavement edge and the extension of the line of the delineators, the delineators should be transitioned to be in line with or inside the innermost edge of the obstruction. If the obstruction is a guardrail or other longitudinal barrier, the delineators should be transitioned to be just behind, directly above (in line with), or on the innermost edge of the guardrail or longitudinal barrier.*

05 *(DE Revision) Post-mounted delineators should be spaced 264 feet apart on mainline tangent sections. Delineators should be spaced no greater than 100 feet along permanent barrier wall. Delineators should be*

*spaced no greater than 100 feet along guardrail. Post-mounted delineators should be spaced no greater than 100 feet apart on ramp tangent sections.*

Support:

06 Examples of delineator installations are shown in Figure 3F-1.

Option:

07 When uniform spacing is interrupted by such features as driveways and intersections, delineators which would ordinarily be located within the features may be relocated in either direction for a distance not exceeding one quarter of the uniform spacing. Delineators still falling within such features may be eliminated.

08 Delineators may be transitioned in advance of a lane transition or obstruction as a guide for oncoming traffic.

Guidance:

09 *The spacing of delineators should be adjusted on approaches to and throughout horizontal curves so that several delineators are always simultaneously visible to the road user. The approximate spacing shown in Table 3F-1 should be used.*

Option:

10 When needed for special conditions, delineators of the appropriate color may be mounted in a closely-spaced manner on the face of or on top of guardrails or other longitudinal barriers to form a continuous or nearly continuous “ribbon” of delineation.

**Table 3F-1. Approximate Spacing for Delineators on Horizontal Curves**

Radius (R) of Curve	Approximate Spacing (S) on Curve
50 feet	20 feet
115 feet	25 feet
180 feet	35 feet
250 feet	40 feet
300 feet	50 feet
400 feet	55 feet
500 feet	65 feet
600 feet	70 feet
700 feet	75 feet
800 feet	80 feet
900 feet	85 feet
1,000 feet	90 feet

NOTES:

1. Spacing for specific radii may be interpolated from table.
2. The minimum spacing should be 20 feet.
3. The spacing on curves should not exceed 300 feet.
4. In advance of or beyond a curve, and proceeding away from the end of the curve, the spacing of the first delineator is 2S, the second 3S, and the third 6S, but not to exceed 300 feet.
5. S refers to the delineator spacing for specific radii computed from the formula  $S=3\sqrt{R-50}$ .
6. The distances for S shown in the table above were rounded to the nearest 5 feet.



## CHAPTER 3G. COLORED PAVEMENTS

### Section 3G.01 General

#### Support:

01 Colored pavements consist of differently colored road paving materials, such as colored asphalt or concrete, or paint or other marking materials applied to the surface of a road or island to simulate a colored pavement.

02 If non-retroreflective colored pavement, including bricks and other types of patterned surfaces, is used as a purely aesthetic treatment and is not intended to communicate a regulatory, warning, or guidance message to road users, the colored pavement is not considered to be a traffic control device, even if it is located between the lines of a crosswalk.

#### Standard:

03 **If colored pavement is used within the traveled way, on flush or raised islands, or on shoulders to regulate, warn, or guide traffic or if retroreflective colored pavement is used, the colored pavement is considered to be a traffic control device and shall be limited to the following colors and applications:**

**A. Yellow pavement color shall be used only for flush or raised median islands separating traffic flows in opposite directions or for left-hand shoulders of roadways of divided highways or one-way streets or ramps.**

**B. White pavement color shall be used for flush or raised channelizing islands where traffic passes on both sides in the same general direction or for right-hand shoulders.**

04 **Colored pavements shall not be used as a traffic control device, unless the device is applicable at all times.**

#### Guidance:

05 *Colored pavements used as traffic control devices should be used only where they contrast significantly with adjoining paved areas.*

06 *Colored pavement located between crosswalk lines should not use colors or patterns that degrade the contrast of white crosswalk lines, or that might be mistaken by road users as a traffic control application.*

(This Page Left Intentionally Blank)

## CHAPTER 3H. CHANNELIZING DEVICES USED FOR EMPHASIS OF PAVEMENT MARKING PATTERNS

### Section 3H.01 Channelizing Devices

#### Option:

01 Channelizing devices, as described in Sections 6F.63 through 6F.73, and 6F.75, and as shown in Figure 6F-7, such as cones, tubular markers, vertical panels, drums, lane separators, and raised islands, may be used for general traffic control purposes such as adding emphasis to reversible lane delineation, channelizing lines, or islands. Channelizing devices may also be used along a center line to preclude turns or along lane lines to preclude lane changing, as determined by engineering judgment.

#### Standard:

02 **Except for color, the design of channelizing devices, including but not limited to retroreflectivity, minimum dimensions, and mounting height, shall comply with the provisions of Chapter 6F.**

03 **The color of channelizing devices used outside of temporary traffic control zones shall be either orange or the same color as the pavement marking that they supplement, or for which they are substituted.**

04 **For nighttime use, channelizing devices shall be retroreflective (as described in Part 6) or internally illuminated. On channelizing devices used outside of temporary traffic control zones, retroreflective sheeting or bands shall be white if the devices separate traffic flows in the same direction and shall be yellow if the devices separate traffic flows in the opposite direction or are placed along the left-hand edge line of a one-way roadway or ramp.**

#### Guidance:

05 *Channelizing devices should be kept clean and bright to maximize target value.*

(This Page Left Intentionally Blank)

## CHAPTER 3I. ISLANDS

### Section 3I.01 General

#### Support:

01 This Chapter addresses the characteristics of islands (see definition in Section 1A.13) as traffic-control devices. Criteria for the design of islands are set forth in “A Policy on Geometric Design of Highways and Streets” (see Section 1A.11).

#### Option:

02 An island may be designated by curbs, pavement edges, pavement markings, channelizing devices, or other devices.

### Section 3I.02 Approach-End Treatment

#### Guidance:

01 *The ends of islands first approached by traffic should be preceded by diverging longitudinal pavement markings on the roadway surface, to guide vehicles into desired paths of travel along the island edge.*

#### Support:

02 The neutral area between approach-end markings that can be readily crossed even at considerable speed sometimes contains slightly raised (usually less than 1 inch high) sections of coarse aggregate or other suitable materials to create rumble sections that provide increased visibility of the marked areas and that produce an audible warning to road users traveling across them. For additional discouragement to driving in the neutral area, bars or buttons projecting 1 to 3 inches above the pavement surface are sometimes placed in the neutral area. These bars or buttons are designed so that any wheel encroachment within the area will be obvious to the vehicle operator, but will result in only minimal effects on control of the vehicle. Such bars or buttons are sometimes preceded by rumble sections or their height is gradually increased as approached by traffic.

#### Guidance:

03 *When raised bars or buttons are used in these neutral areas, they should be marked with white or yellow retroreflective materials, as determined by the direction or directions of travel they separate.*

#### Standard:

04 **Channelizing devices, when used in advance of islands having raised curbs, shall not be placed in such a manner as to constitute an unexpected obstacle.**

#### Option:

05 Pavement markings may be used with raised bars to better designate the island area.

### Section 3I.03 Island Marking Application

#### Standard:

01 **Markings, as related to islands, shall consist only of pavement and curb markings, channelizing devices, and delineators.**

#### Option:

02 Pavement markings as described in Section 3B.10 for the approach to an obstruction may be omitted on the approach to a particular island based on engineering judgment.

### Section 3I.04 Island Marking Colors

#### Guidance:

01 *Islands outlined by curbs or pavement markings should be marked with retroreflective white or yellow material as determined by the direction or directions of travel they separate (see Section 3A.05).*

02 *The retroreflective area should be of sufficient length to denote the general alignment of the edge of the island along which vehicles travel, including the approach end, when viewed from the approach to the island.*

#### Option:

03 On long islands, curb retroreflection may be discontinued such that it does not extend for the entire length of the curb, especially if the island is illuminated or marked with delineators or edge lines.

### **Section 3I.05 Island Delineation**

#### **Standard:**

- 01 **Delineators installed on islands shall be the same colors as the related edge lines except that, when facing wrong-way traffic, they shall be red (see Section 3F.03).**
- 02 **Each roadway through an intersection shall be considered separately in positioning delineators to assure maximum effectiveness.**

#### **Option:**

- 03 Retroreflective or internally illuminated raised pavement markers of the appropriate color may be placed on the pavement in front of the curb and/or on the top of curbed approach ends of raised medians and curbs of islands, as a supplement to or as a substitute for retroreflective curb markings.

### **Section 3I.06 Pedestrian Islands and Medians**

#### **Support:**

- 01 Raised islands or medians of sufficient width that are placed in the center area of a street or highway can serve as a place of refuge for pedestrians who are attempting to cross at a midblock or intersection location. Center islands or medians allow pedestrians to find an adequate gap in one direction of traffic at a time, as the pedestrians are able to stop, if necessary, in the center island or median area and wait for an adequate gap in the other direction of traffic before crossing the second half of the street or highway. The minimum widths for accessible refuge islands and for design and placement of detectable warning surfaces are provided in the “Americans with Disabilities Act Accessibility Guidelines for Buildings and Facilities (ADAAG)” (see Section 1A.11).

## CHAPTER 3J. RUMBLE STRIP MARKINGS

### Section 3J.01 Longitudinal Rumble Strip Markings

#### Support:

01 Longitudinal rumble strips consist of a series of rough-textured or slightly raised or depressed road surfaces intended to alert inattentive drivers through vibration and sound that their vehicle has left the travel lane. Shoulder rumble strips are typically installed along the shoulder near the travel lane. On divided highways, rumble strips are sometimes installed on the median side (left-hand side) shoulder as well as on the outside (right-hand side) shoulder. On two-way roadways, rumble strips are sometimes installed along the center line.

02 (DE Revision) This Manual contains no provisions regarding the design and placement of longitudinal rumble strips. The provisions in this Manual address the use of markings in combination with a longitudinal rumble strip. [DeIDOT's Design Guidance Memorandum Number 1-18: Continuous Centerline and Longitudinal Edge Line Rumble Strips](#) provides guidance regarding the design and placement of rumble strips along state-maintained roadways.

#### Option:

03 An edge line or center line may be located over a longitudinal rumble strip to create a rumble stripe.

#### Standard:

04 **The color of an edge line or center line associated with a longitudinal rumble stripe shall be in accordance with Section 3A.05.**

05 **An edge line shall not be used in addition to a rumble stripe that is located along a shoulder.**

#### Support:

06 Figure 3J-1 illustrates markings used with or near longitudinal rumble strips.

### Section 3J.02 Transverse Rumble Strip Markings

#### Support:

01 Transverse rumble strips consist of intermittent narrow, transverse areas of rough-textured or slightly raised or depressed road surface that extend across the travel lanes to alert drivers to unusual vehicular traffic conditions. Through noise and vibration, they attract the attention of road users to features such as unexpected changes in alignment and conditions requiring a reduction in speed or a stop.

02 This Manual contains no provisions regarding the design and placement of transverse rumble strips that approximate the color of the pavement. The provisions in this Manual address the use of markings in combination with a transverse rumble strip.

#### Standard:

03 **Except as otherwise provided in Section 6F.87 for TTC zones, if the color of a transverse rumble strip used within a travel lane is not the color of the pavement, the color of the transverse rumble strip shall be either black or white.**

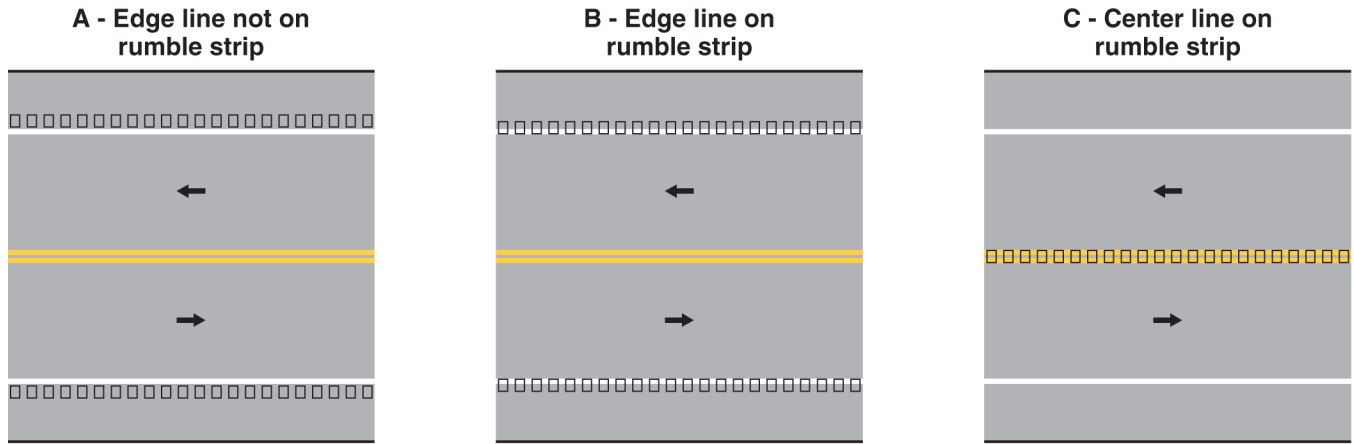
#### Guidance:

04 *White transverse rumble strips used in a travel lane should not be placed in locations where they could be confused with other transverse markings such as stop lines or crosswalks.*

04A (DE Revision) *Raised white transverse rumble strips used in a travel lane to alert motorists of a stop or other condition should be installed in accordance with Table 3J-1.*

04B (DE Revision) *Raised white transverse rumble strips should consist of a 4-inch line placed on top of a 6-inch line.*

**Figure 3J-1. Examples of Longitudinal Rumble Strip Markings**



Legend

Note: Edge line may be located alongside the rumble strip (Option A) or on the rumble strip (Option B). Center line markings may also be located on a center line rumble strip (Option C).

➔ Direction of travel  
 □□□ Rumble strip

**Table 3J-1. Transverse Rumble Strip Placement (Delaware Revision)**

Posted Speed (MPH)	Sets of Strips*	Strip Spacing (inches)	Longitudinal Spacing of Each Set** (feet)
25	4 - 5	24	75
30	4 - 5	24	100
35	4 - 5	24	100
40	4 - 5	30	125
45	4 - 5	30	125
50	4 - 5	36	150
55	4 - 5	36	150

\* Each set consists of five individual strips.

\*\* Spacing between sets of rumble strips and space required before the point at which a speed reduction must be obtained.